

TESmart

User Manual

8x1 HDMI KVM
16x1 HDMI KVM

4◀ Auto 

— HKS801-EB23 & HKS1601-EB23 —

To Enjoy Smart

— HKS801-EB23 & HKS1601-EB23 —

English



English



Preface

It's our great honor that you have chosen the HDMI KVM Switch produced by our company, Tesla Elec Technology Co.,Ltd. In this user manual, you will learn how to operate and use this product. Please read this user manual comprehensively before use. If you have any questions, comments or suggestions, please contact us via the following email:

support@tesmart.com.

Copyright Notice

The user manual, compiled by Tesla Elec Technology Co.,Ltd, shall not be duplicated or translated by any person or organizations without written permission. This user manual shall not be used for commodity transaction in any form or by any means (electronically, mechanically, photocopying or recording, etc.) or be used for any business practices or profitable activities. The ownership of the trade names and brand names adopted in this user manual belongs to their companies.

Product Information

For more information about TESmart products and how they can help you to enjoy your job, please visit the following TESmart website or contact an TESmart Authorized Reseller.

www.tesmart.com

Contents

1. Safety Tips and Warnings.....	01	9.1 Auto Scan Mode	
2. Battery Description.....	02	9.2 Auto Detect Mode	
3. Warranty Information.....	03	9.3 Mouse Wheel Switching	
4. Preface.....	04	10. Operation Method.....	20
5. Features.....	05	10.1 Front Panel Button Switching Method	
6. Packing List.....	06	10.2 IR Remote Control	
7. Panel Description.....	07	10.3 RS232 and LAN Port Control	
7.1 8x1 KVM Switch Panel		10.4 Keyboard Hot Keys	
7.2 16x1 KVM Switch Panel		11. Change Hot Key Combinations.....	34
8. Connection Description.....	11		
8.1 Connection Diagram-8x1 KVM Switch			
8.2 Connection Diagram-16x1 KVM Switch			
8.3 Connection Preparation			
8.4 Connection Steps			
9. Function Description.....	17		

1. Safety Tips and Warnings

Tips: Please read the safety tips and warnings for HDMI KVM Switch comprehensively before use. Use this produce in accordance with its instructions, safety tips and warnings to prevent unnecessary damage to the product and potential dangers to users.

- ⚠ Keep the product away from water.
- ⚠ Clean the product with dry cloth.
- ⚠ Use the product in accordance with its instructions and do not block its vents.
- ⚠ Keep the product away from ignition sources, such as heat sinks, heat accumulators, stovepipe and other heat production settings (including audio amplifiers).
- ⚠ Do not touch the product and the power cord with wet hands so as to lower the risk of electric shock and damage to the product. Do not let the product get wet or become damp.
- ⚠ Unplug the power supply of this product in thunderstorm days or when it has been not used for a long time.
- ⚠ Do not expose this product and its battery to open fire or overheating environment. Dispose the waste battery in accordance with instructions.
- ⚠ Users shall not remove and repair the product without authorization.

2. Battery Description

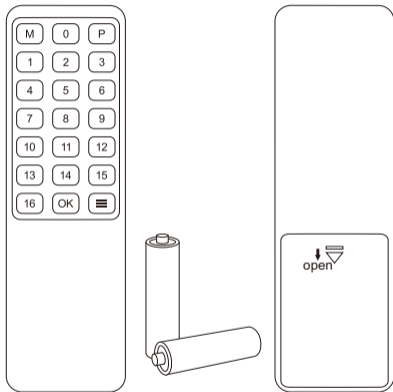

Tips: By default, the remote control is not equipped with batteries, due to the safety requirements of some express companies. Install AAA dry cells before use.

Caution: Improper disposal of the lithium battery may cause an explosion. Do not throw the battery into fire. Keep the battery away from children. Dispose the waste battery in accordance with local regulations.

3. Warranty Information

We warrant this product as free of defects in material and workmanship for a period of one (1) year from the date of shipment. If during the period of warranty this product proves defective under normal use, we will repair or replace this product, provided that this product has not been subjected to mechanical, electrical, or other abuse or modifications. If it fails under conditions other than those covered will be repaired at the current price of parts and labor in effect at the time of repair. Such repairs are warranted for six (6) months from the day of reshipment to the buyer.

4. Preface

Dear Users,

The HDMI KVM Switch can greatly facilitate your management of audio and video devices. It can help you add more inputs to your TV or AV receiver, eliminating the troublesome of unplugging cables and switching devices. Support connect to keyboard and mouse, you can switch input ports with keyboard hot keys conveniently. You can also use front panel buttons, IR signals and RS232 port to switch. At the same time, with EDID emulators in each input port, it can keep source devices always having correct display information.

Tips: If you need to control more devices or conduct more complex and professional switching, you can also choose other products of our company. For more details, please visit our official website: www.tesmart.com.

5. Features

- Using only 1 set of keyboard and mouse to control 1 display and 8/16 PCs at the same time
- Support resolution up to 3840x2160@60Hz
- Support Unix/Windows/Debian/Ubuntu/Fedora/MacOS X/Raspbian/Ubuntu for Raspberry Pi and other Linux based systems
- With EDID emulators in each input ports, keep PCs always have correct display information
- Support auto detect mode
- Support auto scan mode
- Support hot plug, connect or disconnect devices to the KVM at any time without turning off devices
- Easy to control KVM via IR receiver, front panel key, keyboard hot keys and RS232 port
- Support DVI-D single link sources and displays with the use of HDMI-to-DVI adapters

6. Packing List

- 1 * 8X1/16x1 HDMI KVM Switch
- 8 * KVM Cables
- 1 * IR Remote Control
- 1 * IR Receiver Cables
- 1 * DC 12V Power Adapter
- 1 * 3 Pins connector (For RS232)
- 2 * Rack-ears
- 1 * User Manual

Tips: After receipt of the product, please check the packing list carefully to make sure that no components have been lost and no damage to the product has been caused during transportation. If you have any problem, please contact us at any time.

7. Panel Description

7.1 8x1 KVM Switch Panel

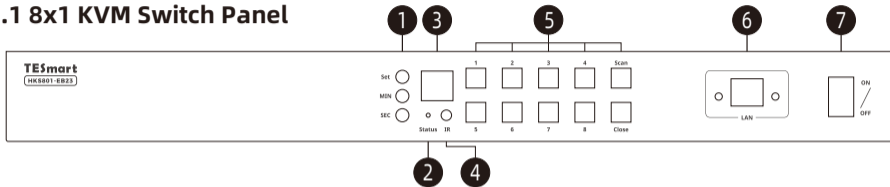

ID	Name	Description	ID	Name	Description
1	Auto scan set buttons	Set auto scan mode time interval.	2	Auto scan state indicator	Indicate current auto scan mode state.
3	Digital display	Digital display	4	IR receiver	Receive IR signal.
5	Keypad	Press to control the KVM. Please refer to Chapter 10.1 for the detail.	6	LAN port	Connect network cable to use TCP/IP commands to control the KVM.
7	Power switch	Turn on or off power supply of the KVM.			

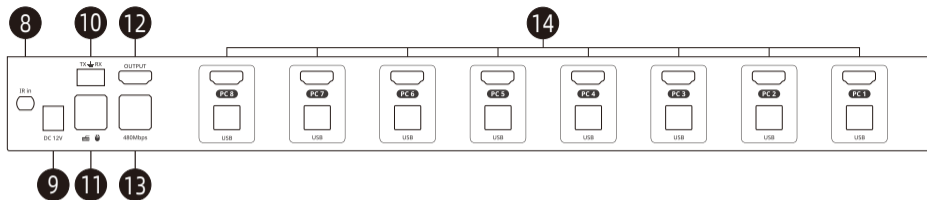

ID	Name	Description	ID	Name	Description
8	IR receiver cable in	Connect IR transmitter cable to this port to pass through IR signal.	9	DC 12V	DC 12V power supply.
10	RS232 port	Connect RS232 cable to use RS232 commands to control the KVM.	11	Keyboard and mouse input	For USB keyboard and mouse input.
12	HDMI Output port	Connect to HDMI display.	13	Standard USB 2.0 ports	Connect to USB 2.0 devices.
14	Input port group	Each group contains an HDMI input port(upper) and a USB port(lower).			

7.2 16x1 KVM Switch Panel

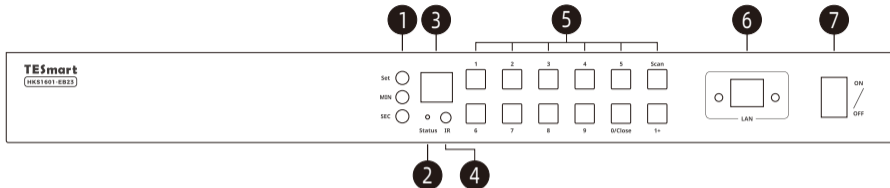

ID	Name	Description	ID	Name	Description
1	Auto scan set buttons	Set auto scan mode time interval.	2	Auto scan state indicator	Indicate current auto scan mode state.
3	Digital display	Digital display	4	IR receiver	Receive IR signal.
5	Keypad	Press to control the KVM. Please refer to Chapter 10.1 for the detail.	6	LAN port	Connect network cable to use TCP/IP commands to control the KVM.
7	Power switch	Turn on or off power supply of the KVM.			

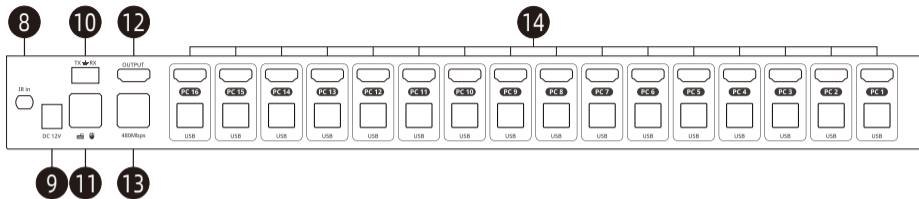

ID	Name	Description	ID	Name	Description
8	IR receiver cable in	Connect IR transmitter cable to this port to pass through IR signal.	9	DC 12V	DC 12V power supply.
10	RS232 port	Connect RS232 cable to use RS232 commands to control the KVM.	11	Keyboard and mouse input	For USB keyboard and mouse input.
12	HDMI Output port	Connect to HDMI display.	13	Standard USB 2.0 port	Connect to USB 2.0 devices.
14	Input port group	Each group contains an HDMI input port(upper) and a USB port(lower).			

8. Connection Description

8.1 Connection Diagram-8x1 KVM Switch

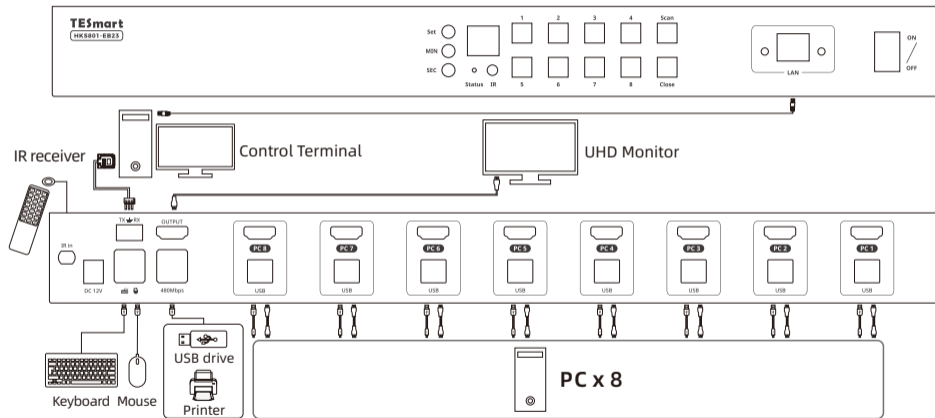

Tips: Please refer to Chapter 10 for how to use the KVM.

8.2 Connection Diagram-16x1 KVM Switch

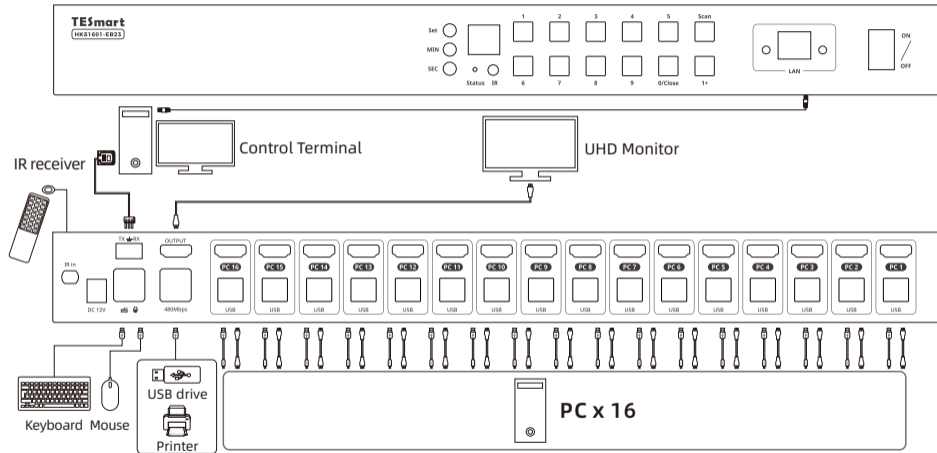

Tips: Please refer to Chapter 10 for how to use the KVM.

8.3 Connection Preparation

- Take into consideration all devices required to be connected and prepare a workbench large enough before the connection.
- Lay out the cables properly to facilitate the layout of power supply as a lot of power sockets and plug boards will be adopted in connection.
- Prepare different sticker labels to mark cables as a lot of cables will be adopted in connection.

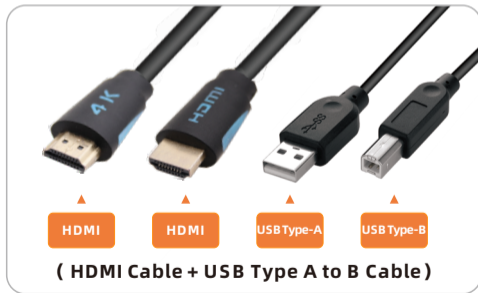

8.4 Connection Steps

Here we take 8x1 KVM Switch as an example to demonstrate the connect steps. The 16x1 KVM Switch is as the same steps to connect.

1. Connect PC1 with 1 KVM cable, use HDMI end to connect PC1 to the HDMI port on the KVM, use USB Type-A end to connect PC1 and Type-B end to connect the KVM.



2. Connect PC 2~8/16 with the same method.

3. Connect external mouse and keyboard to KVM's keyboard and mouse input port.



Tips: For the normal service of hotkeys, we recommend you use the full-key external keyboard with a separate [Scroll Lock] key (as shown above).

4. Connect USB 2.0 devices to KVM's standard USB 2.0 ports.



or



5. Connect KVM's HDMI output port to an HDMI displays with an HDMI cable.



6. Connect the power cable to KVM's DC 12V port and plug it to a power socket.



7. By now, the connection has been completed. Turn on the power supply and the KVM Switch will begin to work.

9. Function Description

9.1 Auto Scan Mode

Auto Scan can automatically switch the display at regular intervals between the input devices that are powered on and connected to the KVM. As a result, any input devices connected to each port can be monitored without user intervention. Auto scan mode is off by default.

The LED named 'Status' on the HDMI KVM's front panel will be lit in different colors when the auto scan mode is turned on or turned off.

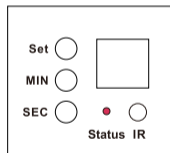

Auto scan mode
turn off

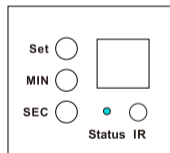

Auto scan mode
turn on

Tips: Please refer to Page 20 and 33 for detailed information about how to set the auto scan mode.

9.2 Auto Detect Mode

The auto detect mode means the KVM will automatically select the input source when:

1. When attaching a new active input device to the KVM, the KVM will switch to this just plugged in source automatically.
2. When removing a connected input source, the KVM will switch to the next active input source automatically.

Turn on/off auto detection mode

Auto detection mode is on by default. Press button **[M]** on the IR remote control can turn on or turn off the auto detection mode.

9.3 Mouse Wheel Switching

Mouse wheel switching method can quickly switch input sources by mouse operation, double-click the mouse wheel to switch to the next input port. Mouse wheel switching mode is off by default. You can use keyboard hotkey command to turn on mouse wheel switching mode. Please refer to Page 32.



10. Operation Method

10.1 Front Panel Button Switching Method

Here we use the front panel of 16x1 KVM Switch to demonstrate the function of the buttons.



Set ●

MIN ●

SEC ●

Auto scan time interval settings buttons:

Use these buttons to set the time interval from 5 seconds to 1 hour.

Step 1: Press button **[MIN]** to loop between 0~59 minutes.

Step 2: Press button **[SEC]** to loop between 0~59 seconds. When the interval is less than 5 sec, it will be fixed in 5 sec.

Step 3: After setting minutes and seconds, press the button **[Set]** to set final auto scan time interval.

**1~9 buttons:**

Press [1~9] button directly to choose the desired 1~9 input port to display.



0/Close

Low-power consumption mode button:

Press [0/Close] button to turn off the HDMI display to reduce the power consumption. Press it again to turn on the HDMI display.

Scan

**Auto scan mode switch button:**

Press [Scan] button to turn on or turn off the auto scan mode.



1+

1+ button:

Press [1+] button, then press [0/Close]/[1~6] within 2 seconds to choose the desired 10~16 input port to display.

Tips: Buttons [9],[1+] are not exist in the 8x1 KVM Switch.

10.2 IR Remote Control

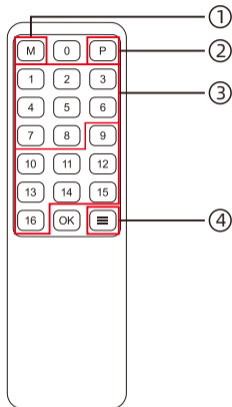

① — Turn on/off auto detect mode

② — Turn on/off auto scan mode

③ — Select inputs 1~8/1~16

④ — Turn on/off buzzer sound

Tips: Unspecified buttons at above are non-functional.

10.3 RS232 Port and LAN Port Control

480Mbps

EN

10. Operation Method

A. Connect RS232 port and LAN port

Follow the below diagram to connect the standard 9 pin RS232 port to the 3 pins connector which is included in package, then plug the connector to the 'TX \neq RX' port of the KVM. Connect the LAN port to local area network router or directly to PC with Cat5e/6 UTP/FTP cable.

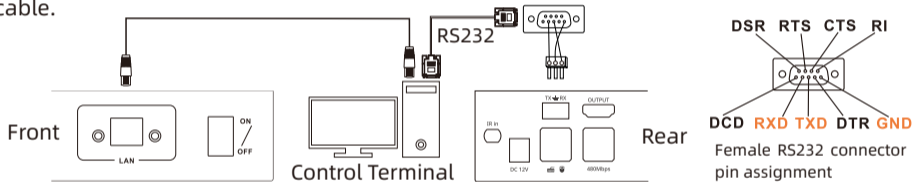

B. Communication protocol

RS232 port configuration:

Baud rate: 9600 bps

Stop bit: 1 bit

Data length: 8 bits

Parity bit: None

LAN port configuration:

IP address: 192.168.1.10

Port: 5000

Gate way: 192.168.1.1

Mask address: 255.255.255.0

The commands are as the following form:

Index	Command strings	Parameter description	Remark
1	0xAA 0xBB 0x03 0x01 0xXX 0xEE	XX: Input port number (01-16) 01-PC1,...,16-PC16	Switch input source.
2	0xAA 0xBB 0x03 0x03 0xXX 0xEE	XX: Digital display time out value (0A, 1E, 00) 0A-10s, 1E-30s, 00-Never	Set the digital display out after 10s/30s, or never out.
3	0xAA 0xBB 0x03 0x02 0xXX 0xEE	XX: Buzzer status (00, 01) 00-Mute, 01-Unmute	Mute or unmute buzzer.
4	0xAA 0xBB 0x03 0x81 0xXX 0xEE	XX: Auto detect mode setting (00, 01) 00-Turn off, 01-Turn on	Turn on or turn off auto detect mode.

Based on the commands above, we provide a controller on the Windows OS. You can visit our official website to download it: www.tesmart.com.

You can also develop dedicated controllers for each platform by referring to the control protocol above.

C. KVM Switch Controller Connection Steps:

RS232 port usage

- Step 1: Use RS232 cable connect PC to the KVM Switch.
- Step 2: Running the KVM Switch Controller. Select page '**General**' and click '**Serial control**'.
- Step 3: Select the serial communication port number which is connected to the KVM Switch.
- Step 4: Click '**Connect**' to connect to the KVM Switch. Then wait until the red indicator beside the button turns green.
- Step 5: Click below buttons to control the KVM Switch.

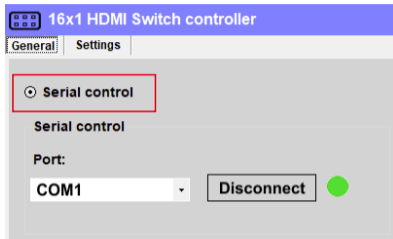

(RS232 serial port connection successful)

Tips: We use 16x1 KVM Switch Controller to demonstrate connection steps and the functions. The 8x1 KVM Switch Controller is used in the same way.

LAN port usage

- Step 1: Use Network cable connect PC to the KVM Switch. Please make sure the PC and the KVM Switch both on the same network segment.
- Step 2: Set the IP address of the network adapter on the PC which is running this software, make sure the IP address is between 192.168.1.2~192.168.1.254 except for 192.168.1.10. Please follow the picture on the next page to set.
- Step 3: Running the KVM Switch Controller. Select page '**General**' and click '**Network control**'.
- Step 4: Click button '**Connect**' in network control section, then wait until the red indicator beside the button turns green.
- Step 5: Click below buttons to Control the KVM Switch.

Tips: 1. The default IP address is 192.168.1.10. The default port number is 5000.
2. If the connection fails, please check if the Cat cable is connected to the PC, the KVM Switch is powered on and the IP address setting of the PC is correct.

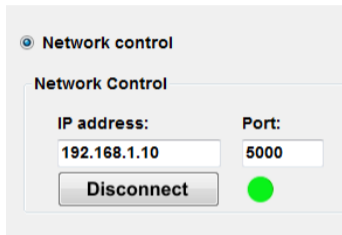

(LAN port connection successful)

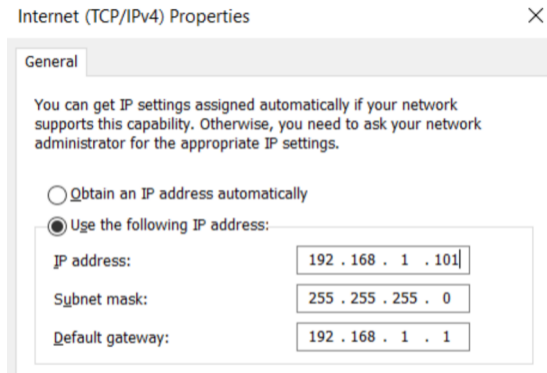

(IP address configuration)

D. KVM Switch Controller Page Description

16x1 HDMI Switch controller

General Settings

1 Serial control

Serial control

Port: COM1 [Connect] ●

2 Network control

Network Control

IP address: 192.168.1.10 Port: 5000 [Connect] ●

3

PC 1 PC 2 PC 3 PC 4 PC 5 PC 6 PC 7 PC 8

PC 9 PC 10 PC 11 PC 12 PC 13 PC 14 PC 15 PC 16

4

Mute Buzzer Auto input detect off LED display timeout Never [Apply]

Unmute Buzzer Auto input detect on

Page 'General':

This page is used for connecting, switching and simple system setup. You can conveniently match input and output devices according to your needs.

- 1 - Serial connect
- 2 - Network connect
- 3 - Select input port
- 4 - System settings

System settings:

- 1) Mute buzzer: Click to make the buzzer on the KVM will mute when you press any button.
Unmute buzzer: Click to make the buzzer on the KVM beep when you press any button.
- 2) Auto input detect off: Click to turn off auto detect mode, the KVM will not switch inputs automatically when plug new input in or removing a connected input.
Auto input detect on: Click to turn on auto detect mode, the KVM will switch inputs automatically when plug new input in or removing a connected input.
- 3) LED display timeout setting:
10 seconds: The digital display on the front panel will be turned off after 10 seconds of inactivity.
30 seconds: The digital display on the front panel will be turned off after 30 seconds of inactivity.
Never: The digital display will always stay on.

Mute Buzzer	Auto input detect off	LED display timeout	
Unmute Buzzer	Auto input detect on	30 Seconds ▾	Apply

Page 'Settings' :

This page is used to set the parameters to use the LAN port to connect the KVM Switch. Also you can change IP address of the KVM Switch with the block 1 and query current network configurations of the KVM Switch with the block 2.

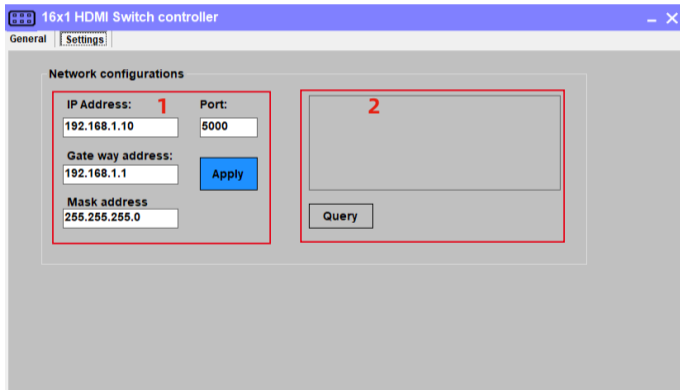

1-Set KVM Switch's network parameters

2-Query current network configuration

10.4 Keyboard Hot Keys

→ Use external keyboard hot keys to switch the input source or set up some other functions..

Tips: The keyboard hot keys can only work with external keyboard correctly connected to the keyboard and mouse input port of the KVM. The default hot key trigger key is **[Right-Ctrl]**.

After press **[Right-Ctrl]** key twice within 2 seconds and you will hear the buzzer beep once, please enter the commands within 3 seconds and the KVM will execute the corresponding commands.

Select next input port:

[Right-Ctrl]→[Right-Ctrl]→[PgUp]



Select previous input port:

[Right-Ctrl]→[Right-Ctrl]→[PgDn]



Select port by port number(For 8x1 KVM Switch):

[Right-Ctrl]→[Right-Ctrl]→[1]~[8]



Select port by port number (For 16x1 KVM Switch):

[Right-Ctrl]→[Right-Ctrl]→[1]~[9]



[Right-Ctrl]→[Right-Ctrl]→[1]→[0]~[6]



The following hot-key commands do work for both 8x1 KVM Switch and 16x1 KVM Switch:

Turn on/off mouse wheel switching mode:

[Right-Ctrl] → [Right-Ctrl] → [F6]



Tips: Turning on the mouse wheel switching mode will trigger the buzzer to beep twice and turning it off will trigger the buzzer to beep once.

Disable or enable buzzer sound:

[Right-Ctrl] → [Right-Ctrl] → [F11]



Tips: The default setting of buzzer sound is enabled. Disable buzzer sound will trigger the buzzer to beep once and enable it will trigger the buzzer to beep twice.

Enable auto scan mode:
[Right-Ctrl] → [Right-Ctrl] → [Space]



Tips: The default auto scan time interval is 15 seconds. You can change the time interval by the front panel buttons or following the step presented below.

Increase or decrease auto scan time interval:
[Right-Ctrl] → [Right-Ctrl] → [+] / [-]



Tips: This hot key command can only work while the auto scan mode is activated. Press [Right-Ctrl] twice and keep pressing [+] / [-] key to adjust the time interval continuously. Increase or decrease 1 second at one time.

Press [Esc] to exit auto scan mode.



Tips: Enabling the auto scan mode will trigger the buzzer to beep twice and disabling it will trigger the buzzer to beep once.

11. Change Hot Key Combinations

There are two kinds of trigger hot keys in this product, the default is **[Right-Ctrl]** key, and the alternative is the **[Scroll Lock]** key. If **[Right-Ctrl]** Key has been used for other functions, you can switch the hot key to **[Scroll Lock]** by:

- Press **[Right-Ctrl]**→**[Right-Ctrl]**→**[F1]**, and you will switch the control hot key to **[Scroll Lock]**.

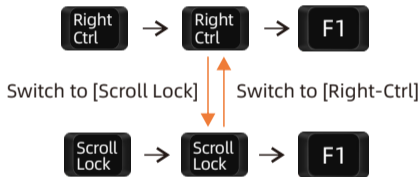

- Vice versa, Press **[Scroll Lock]**→**[Scroll Lock]**→**[F1]**, and you will switch the control hot key to **[Right-Ctrl]**.

TESmart

To Enjoy Smart

— HKS801-EB23 & HKS1601-EB23 —

Tesla Elec Technology Co.,Ltd

CE FC   HDCP 

WEEE-Reg.-Nr. DE 66784279