

TESmert TESmart

User Manual

8x1 HDMI Switch
16x1 HDMI Switch



HSW0801A1U & HSW1601A1U

To Enjoy Smart

HSW0801A1U & HSW1601A1U

English

TESmert TESmart



English



Preface

It's our great honor that you have chosen the HDMI switch produced by our company, Tesla Elec Technology Co.,Ltd. In this user manual, you will learn how to operate and use this product. Please read this user manual comprehensively before use. If you have any questions, comments or suggestions, you can contact us via the following email:

tech@tesmart.com.

Copyright Notice

The user manual, compiled by Tesla Elec Technology, shall not be duplicated or translated by any person or organizations without written permission. This user guide shall not be used for commodity transaction in any form or by any means (electronically, mechanically, photocopying or recording, etc.) or be used for any business practices or profitable activities. The ownership of the trade names and brand names adopted in this user manual belongs to their companies.

Address of Manufacture

Tesla Elec Technology Co.,Ltd

2F, Building C, Xingzhisheng Industrial Park, No.12,

Xiawei Industrial Zone, Zhangkengjing Road,

Guanlan Street,

Longhua District, Shenzhen City,









Guangdong Province, China

Contents

1. Safety Tips and Warnings	01	10. Function Description	14
2. Battery Description	02	10.1 Front Panel Button Switching Method	
3. Warranty Information	03	10.2 Low consumption mode	
4. Preface	04	10.3 IR Remote Control	
5. Features	05	10.4 Auto scan mode	
6. Packing List	06	10.5 Auto detection mode	
7. Panel Description(8x1 HDMI Switch)	07	10.6 RS232 port and LAN port control	
8. Panel Description(16x1 HDMI Switch)	09		
9. Connection Description	11		
9.1 Connection Diagram(8x1 HDMI Switch)			
9.2 Connection Diagram(16x1 HDMI Switch)			
9.3 Connection Steps			

1. Safety Tips and Warnings

Tips: Read the safety tips and warnings for HDMI Switch comprehensively before use. Use this produce in accordance with its instructions, safety tips and warnings to prevent unnecessary damage to the product and potential dangers to users.

-  Keep the product away from water.
-  Clean the product with dry cloth.
-  Use the product in accordance with its instructions and do not block its vents.
-  Keep the product away from ignition sources, such as heat sinks, heat accumulators, stovepipes and other heat production settings (including audio amplifiers).
-  Do not touch the product and the power cord with wet hands so as to lower the risk of electric shock and the damage to the product. Do not let the product get wet or become damp.
-  Unplug the power supply of this product in thunderstorm days or when it has been not used for a long time.
-  Do not expose this product and its battery to open fire or overheating environment. Dispose the waste battery in accordance with instructions.
-  Users shall not remove and repair the product without authorization.

2. Battery Description

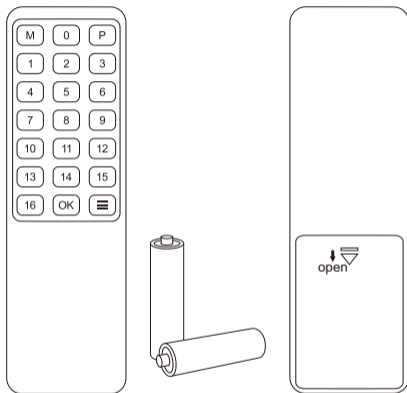

Tips: By default, the remote control is not equipped with batteries, due to the safety requirements of some express companies. Install AAA dry cells before use.

Caution: Improper disposal of the lithium battery may cause an explosion. Do not throw the battery into fire. Keep the battery away from children. Dispose the waste battery in accordance with local regulations.



3. Warranty Information

We warrant that this product will be free of defects in material and workmanship for a period of one (1) year from the date of shipment. If within the period of warranty this product proves defective under normal use, we will repair or replace this product, provided that the product has not been subjected to mechanical and electrical damage, or other abuse or modifications. If it fails under conditions other than those covered, its repair will be charged in accordance with the current price of parts and labor in effect at the time of repair. Such repairs are warranted for six (6) months from the day of reshipment to the buyer.

4. Preface

Dear Users:

HDMI Switch can greatly facilitate your management of audio and video devices. If you have a home theater or entertainment setup with multiple sources and display devices like game consoles, streaming boxes, and projectors, it can be hard to manage in terms of cables and switching devices. Our HDMI switch can help you add more inputs to your TV or AV receiver if you have too many devices to manage.

You can switch input ports with front panel buttons, IR signals, RS232 port and LAN port. At the same time, with EDID emulators in each input port, it can keep source devices always having correct display information.

Tips: If you need to control more devices or conduct more complex and professional switching, you can also choose other products of our company. For more details, you can visit our official website: www.tesmart.com.

5. Features

- With 8/16 HDMI inputs and 1 HDMI output
- Support resolution up to 3840*2160@60Hz 4:4:4
- HDCP 2.2 compliant
- With EDID emulators in each port, keep HDMI sources always have correct display information
- Support front panel buttons, IR signals, RS232 serial commands or IP commands to control HDMI switch
- Support auto scan mode
- Support auto detection mode

6. Packing List

- 1 * 8x1/16x1 HDMI Switch
- 1 * DC 12V Power Adapter
- 1 * IR Remote Control
- 1 * IR Receive cable
- 1 * 3 Pins Connector (For RS232)
- 2 * Rack-ears
- 1 * User Manual

Tips: After received the product, you should check the packing list carefully to make sure that no components have been lost and no damage to the product has been caused during transportation. If you have any problems, you can contact with us.

7. Panel Description (8x1 HDMI Switch)

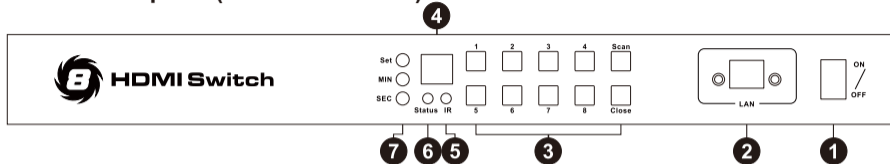

ID	Name	Description	ID	Name	Description
1	Power switch	Turn on or off power supply of the switch.	4	LED display	Display current selected input source number.
2	LAN port	Connect this port to local area network with network cable. Use TCP/IP commands to select input source.	5	IR receiver	Receive IR signal.
3	Keypad	Press these buttons to control the switch.	6	Auto scan status LED	Green: Turn on auto scan mode; Red: Turn off auto scan mode.
7	Auto scan time interval settings	[MIN]: Press this button to loop between 0~59 minutes; [SEC]: Press this button to loop between 0~59 seconds; [Set]: After setting minutes and seconds, press this button to set final auto scan time interval.			

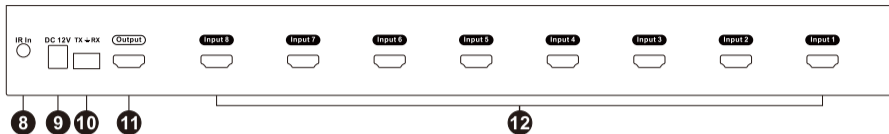

ID	Name	Description
8	IR extension in	Connect IR receive cable to this port to receive IR signal even the switch is installed in a rack.
9	DC 12V	DC 12V power supply.
10	RS232 port	Connect this port to control terminal. Use RS232 commands to select input source.
11	HDMI output port	Connect to HDMI display.
12	HDMI input ports	Connect to HDMI source devices.

8. Panel Description (16x1 HDMI Switch)

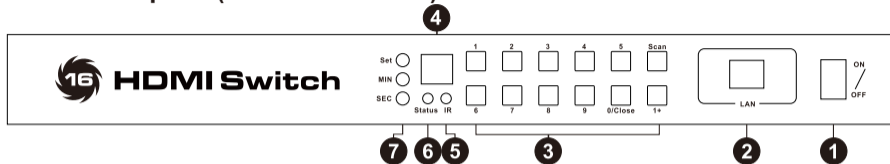

ID	Name	Description	ID	Name	Description
1	Power switch	Turn on or off power supply of the switch.	4	LED display	Display current selected input source number.
2	LAN port	Connect this port to local area network with network cable. Use TCP/IP commands to select input source.	5	IR receiver	Receive IR signal.
3	Keypad	Press these buttons to control the switch.	6	Auto scan status LED	Green: Turn on auto scan mode; Red: Turn off auto scan mode.
7	Auto scan time interval settings	[MIN]: Press this button to loop between 0~59 minutes; [SEC]: Press this button to loop between 0~59 seconds; [Set]: After setting minutes and seconds, press this button to set final auto scan time interval.			

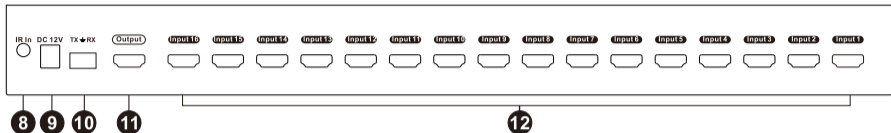

ID	Name	Description
8	IR extension in	Connect IR receive cable to this port to receive IR signal even the switch is installed in a rack.
9	DC 12V	DC 12V power supply.
10	RS232 port	Connect this port to control terminal. Use RS232 commands to select input source.
11	HDMI output port	Connect to HDMI display.
12	HDMI input ports	Connect to HDMI source devices.

9. Connection Description

9.1 Connection Diagram (8x1 HDMI Switch)

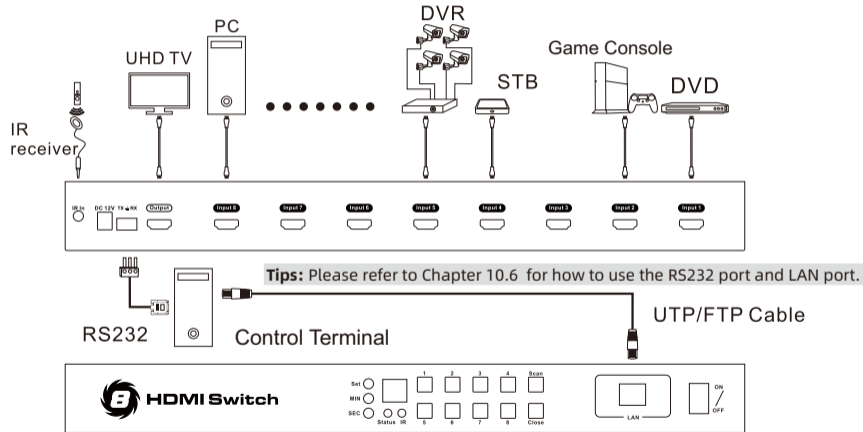

9.2 Connection Diagram (16x1 HDMI Switch)

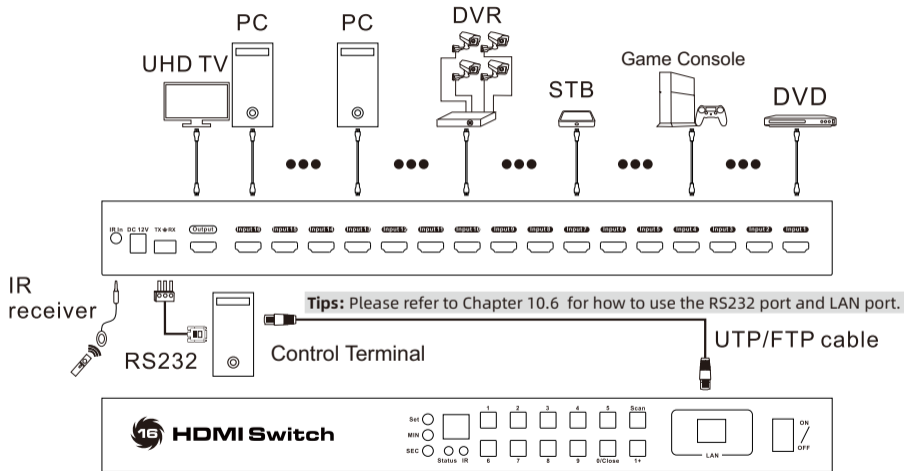

9.3 Connection Steps

1. Connect the input device to the input ports using 8 or 16 HDMI cables.
2. Connect the output port to the display device using 1 HDMI cable.
3. Connect DC 12V power supply to the HDMI Switch.
4. By now, the connection has been completed. Turn on the power supply and the HDMI Switch will begin to work.

Tips: Please refer to Chapter 10 for detailed information about how to use the HDMI Switch.

10. Function Description

10.1 Front Panel Button Switching Method

8x1 HDMI Switch

Directly press button [1] ~ [8] to select input 1~8;

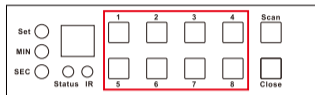

16x1 HDMI Switch

Directly press button [1] ~ [16] to select input 1~16;

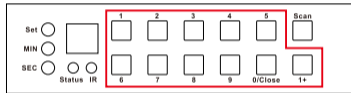

10.2 Low consumption mode

Directly press button [Close] (for 8x1) or [0/Close] (for 16x1) to turn on or off the HDMI display.

Tips: The low consumption mode starts when the [Close] button is pressed, and the HDMI switch output will then be turned off, but the HDMI input source and the switcher will remain connected. You can instantly restore the output at any time by pressing the [Close] button again.

10.3 IR Remote Control

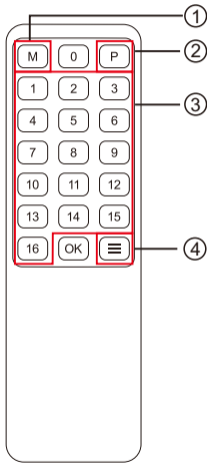

①—Turn on/off auto detection mode

②—Turn on/off auto scan mode

③—Select input port
8x1: Press [1]~[8] to select input 1~8;
16x1: Press [1]~[16] to select input 1~16

④—Mute / unmute buzzer

Tips: 1. Please refer to Chapter 10.4 for detailed information about how to use the auto scan mode.
2. Please refer to Chapter 10.5 for detailed information about how to use the auto detection mode.

10.4 Auto Scan mode

The Auto Scan feature automatically toggles the HDMI Switch focus between the connected powered on input units at regular intervals. As a result, any input devices connected to each can be monitored without user intervention. Auto scan mode is off by default.

Turn on/off auto scan mode

1. Press button [Scan] on the HDMI Switch front panel.
2. Press button [P] on the IR remote control.

The LED named 'Status' on the HDMI Switch front panel will be lit in different colors when the auto scan mode turn on or turn off.

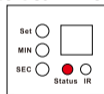

Auto scan mode
turn off

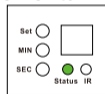

Auto scan mode
turn on

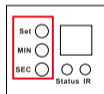

Time interval setting
button

Auto scan time interval settings: Auto scan time interval is 15 seconds by default. You can use the time setting button on the front panel to set the time interval from 5 seconds to 1 hour.

Step 1: Press button [MIN] to loop between 0~59 minutes;

Step 2: Press button [SEC] to loop between 0~59 seconds;

Step 3: After setting minutes and seconds, press button [Set] to set final auto scan time interval.

10.5 Auto Detection mode

The HDMI Switch will automatically select the input source when:

1. When attaching a new input device to the switch, the HDMI switch will switch to this just plugged in source automatically.
2. When removing a connected input source, the HDMI switch will switch to the first valid input source automatically.
3. If the HDMI switch is connected to a non-signal input port, the HDMI switch will switch to the next valid port automatically in a few seconds.

Turn on/off auto detection mode

Auto detection mode is on by default. Press button [M] on the IR remote control can turn on or turn off the auto detection mode.

10.6 RS232 port and LAN port control

A. Connect RS232 port

Follow below diagram to connect the standard 9 pin RS232 port to the 3 pins connector which is included in package, then plug the connector to the HDMI switch 'TX \pm RX' port.



B. Connect LAN port

Follow below diagram to connect the LAN port to local area network router or directly to PC with Cat5e/6 UTP cable.

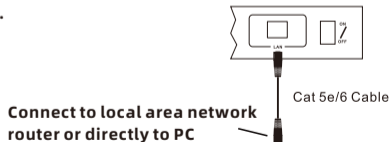

C. Communication protocol

RS232 port configuration:

Baud rate: 9600 bps

Stop bit: 1 bit

Data length: 8 bits

Commands (HEX Format):

Switch input source:

Switch to PC X : 0xAA 0xBB 0x03 0x01 0xFF 0xEE

(X: 1~8 for 8x1 HDMI Switch; 1~16 for 16x1 HDMI Switch);

(XX: 0x01-PC1, 0x02-PC2, ...0x08-PC8, ...0x10-PC16);

LED timeout setting:

Set LED timeout X : 0xAA 0xBB 0x03 0x03 0xFF 0xEE

(X: 10s, 30s, Never); (XX: 0x0A-10s, 0x1E-30s, 0x00-Never);

Buzzer setting:

Mute buzzer: 0xAA 0xBB 0x03 0x02 0x00 0xEE

Unmute buzzer: 0xAA 0xBB 0x03 0x02 0x01 0xEE

Auto detection mode setting:

Turn off: 0xAA 0xBB 0x02 0x81 0x00 0xEE

Turn on: 0xAA 0xBB 0x02 0x81 0x01 0xEE

LAN port configuration:

IP address: 192.168.1.10

Port: 5000

Gate way: 192.168.1.1

Mask address: 255.255.255.0

D. 8x1/16x1 HDMI Switch controller

Based on the communication protocol in Section C, we provide a controller on the windows OS. you can visit our official website to download it:

www.tesmart.com.

You can also develop dedicated controllers for each platform by referring to the control protocol in Section C.

Page description

Page 'Settings' :

- 1 - HDMI Switch LAN port setting
- 2 - Query current information

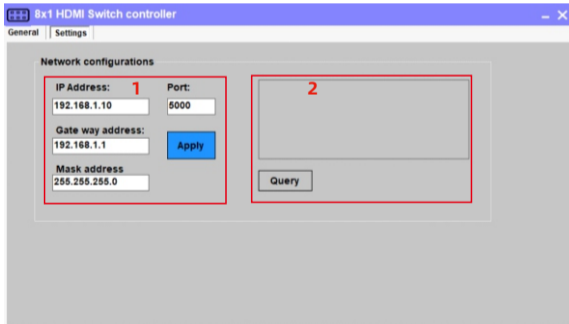

Page description

Page 'General' :

- 1 - Serial connect
- 2 - Network connect
- 3 - Input ports settings
- 4 - System settings

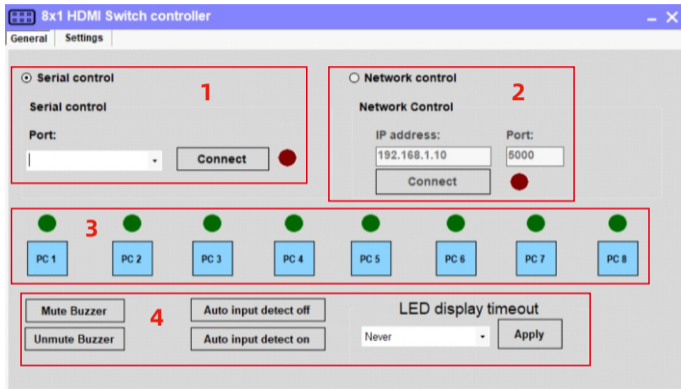

RS232 port usage:

Step 1: Use RS232 cable connect PC to HDMI Switch.

Step 2: Running the HDMI Switch Controller. Select page 'General' and click 'Serial control'.

Step 3: Select the serial communication port number which connected to the HDMI Switch.

Step 4: Click 'Connect' to open the serial port and connect to the HDMI Switch.

Step 5: After connected, click PC 1/PC 2/.../PC 16 (PC 9 ~ PC 16 only for 16x1 HDMI Switch) button to select the input source.

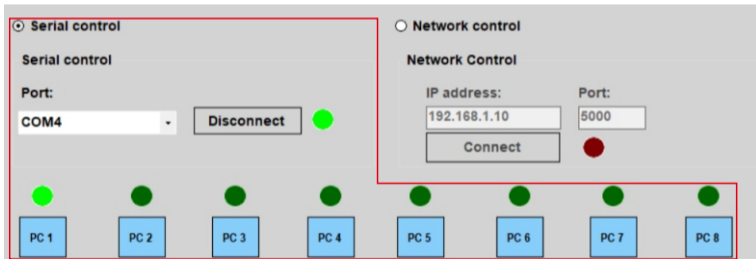

(RS232 Serial Port connect successful)

LAN port usage:

- Step 1: Use Network cable connect PC or to HDMI Switch. Please make sure the PC and the HDMI Switch both to the same Local area network.
- Step 2: Running the HDMI Switch Controller. Select page 'General' and click 'Network control'.
- Step 3: Setup IP address of the network adapter on the PC which running this software, make sure the IP address is between 192.168.1.2~192.168.1.254 but should not be 192.168.1.10. Please take the picture for example in next page.
- Step 4: Click button 'Connect' in network control section, the button will be changed to 'Connecting...!', please wait for seconds, if succeed, the red indicator beside the button will change to green. If failed, please check if the cat cable is connected to the PC, the switch is powered on and the IP address setting of the PC is correct.
- Step 5: After connected, click PC 1/PC 2/.../PC 16 (PC 9 ~ PC 16 only for 16x1 HDMI Switch) button to select the input source.

LAN port usage:

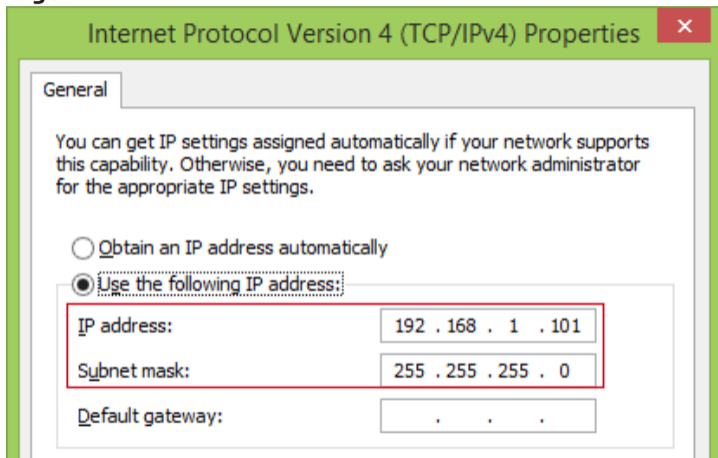

(IP address configuration)

LAN port usage:

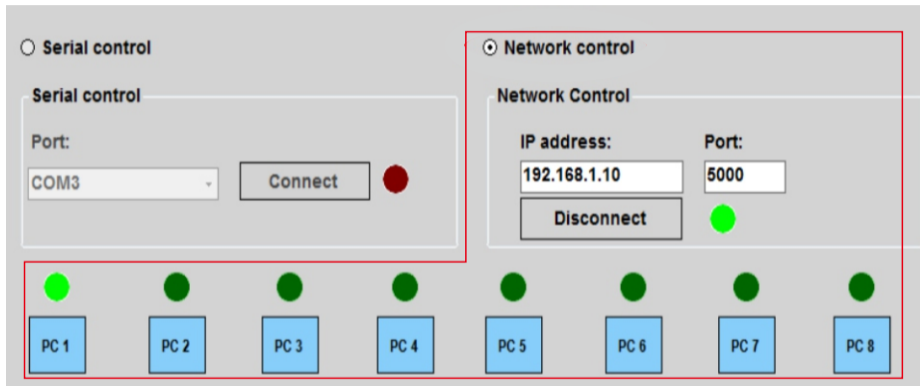

(LAN Port connect successful)

System settings:

- 1) Mute buzzer: Turn off the buzzer, the buzzer on HDMI switch will not beep when press buttons.
Unmute buzzer: Turn on the buzzer, the buzzer on HDMI switch will beep when press buttons.
- 2) Auto input detect off / Auto input detect on:
Turn off or turn on Auto detection mode.

Tips: Please refer to Chapter 10.5 for detailed information about how to use the auto detection mode.

- 3) LED display timer out setting:
10 seconds: The LED display on the from panel will be turn off after 10 seconds no operation.
30 seconds: The LED display on the from panel will be turn off after 30 seconds no operation.
Never: The LED display will be always on

Mute Buzzer	Auto input detect off	LED display timeout	
Unmute Buzzer	Auto input detect on		
		30 Seconds ▾	Apply

Change IP address of the HDMI switch:

Step 1: Use RS232 cable connect PC to HDMI Switch.

Step 2: Running the HDMI Switch Controller. Select page 'General' and click 'Serial control'.

Step 3: Select the serial communication port number which connected to the HDMI Switch.

Step 4: Click 'Connect' to open the serial port and connect to the HDMI Switch.

Step 5: Select page 'Settings' .

Step 6: Modified the IP address and the port value to you want, then press 'Apply' button to change the IP settings of the HDMI Switch. And then you could press button 'Query' to see if the IP settings are changed as you want.

Step 7: Restart the HDMI switch, and then the IP settings of the HDMI Switch will be changed.

Change IP settings of the HDMI switch:

The screenshot shows a web interface for configuring an HDMI switch. At the top, there are two tabs: "General" and "Settings". The "Settings" tab is active. Below the tabs, there is a section titled "Network configurations". This section contains several input fields and buttons:

- IP Address:** Input field containing "192.168.1.10"
- Port:** Input field containing "5000"
- Gate way address:** Input field containing "192.168.1.1"
- Mask address:** Input field containing "255.255.255.0"
- Apply:** A blue button to save the changes.
- Query:** A button to retrieve the current settings.

To the right of the input fields, there is a summary box displaying the current configuration:

- IP address: 192.168.001.010
- Port: 05000
- Gate way address: 192.168.001.001
- Mask address: 255.255.255.000

Red boxes highlight the "Network configurations" section, the "Apply" button, and the "Query" button.

(Change IP settings)

TESmert TESmart

To Enjoy Smart

HSW0801A1U & HSW1601A1U

Tesla Elec Technology Co.,Ltd

CE FC   HDCP 

WEEE-Reg.-Nr. DE 66784279