

User **4x2** DisplayPort KVM Switch Manual

DKS402 Master 24

English



English



Preface

It's our great honor that you have chosen the KVM Switch produced by our company, TESmart Tech Co.,Ltd. In this user manual, you will learn how to operate and use this product. Please read this user manual comprehensively before use. If you have any questions, comments or suggestions, please contact us via the following email: support@tesmart.com.

Copyright Notice

The user manual, compiled by TESmart Tech Co.,Ltd, shall not be duplicated or translated by any person or organizations without written permission. This user manual shall not be used for commodity transaction in any form or by any means (electronically, mechanically, photocopying or recording, etc.) or be used for any business practices or profitable activities. The ownership of the trade names and brand names adopted in this user manual belongs to their companies.

Product Information

For more information about TESmart products and how they can help you to enjoy your job, please visit the following TESmart website or contact a TESmart Authorized Reseller.

www.tesmart.com

Contents

1. Safety Tips and Warnings	01	9.4 Built-in Network Switch	
2. Battery Description.....	02	9.5 Lock L/R Audio and USB Function	
3. Warranty Information.....	03	9.6 Auto Scan Mode Description	
4. Preface.....	04	9.7 Mouse Wheel Switching	
5. Features.....	05	9.8 Built-in Charging Module	
6. Packing List.....	06	10. Operation Method.....	27
7. Panel Description.....	07	10.1 Front Panel Button Switching Method	
8. Connection Description.....	11	10.2 IR Remote Control	
8.1 Connection Diagram		10.3 Keyboard Hot Keys	
8.2 Connection Preparation		11. Change Hot Key Combination.....	38
8.3 Connection Steps			
8.4 KVM Workbench			
9. Function Description.....	18		
9.1 Display Mode Description			
9.2 EDID Emulator			
9.3 Keyboard and Mouse Emulation Mode			

1. Safety Tips and Warnings

Tips: Please read the safety tips and warnings for dual monitor KVM Switch comprehensively before use. Use this produce in accordance with its instructions, safety tips and warnings to prevent unnecessary damage to the product and potential dangers to users.

- ⚠ Keep the product away from water.
- ⚠ Clean the product with dry cloth.
- ⚠ Use the product in accordance with its instructions and do not block its vents.
- ⚠ Keep the product away from ignition sources, such as heat sinks, heat accumulators, stovepipes and other heat production settings (including audio amplifiers).
- ⚠ Do not touch the product and the power cord with wet hands so as to lower the risk of electric shock and damage to the product. Do not let the product get wet or become damp.
- ⚠ Unplug the power supply of this product in thunderstorm days or when it has been not used for a long time.
- ⚠ Do not expose this product and its battery to open fire or overheating environment. Dispose the waste battery in accordance with instructions.
- ⚠ Users shall not remove and repair the product without authorization.

2. Battery Description

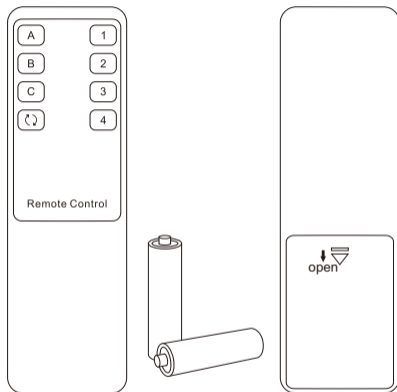

Tips: By default, the remote control is not equipped with batteries, due to the safety requirements of some express companies. Install AAA dry cells before use.

Caution: Improper disposal of the lithium battery may cause an explosion. Do not throw the battery into fire. Keep the battery away from children. Dispose the waste battery in accordance with local regulations.



3. Warranty Information

We warrant this product as free of defects in material and workmanship for a period of one (1) year from the date of shipment. If during the period of warranty this product proves defective under normal use, we will repair or replace this product, provided that this product has not been subjected to mechanical, electrical, or other abuse or modifications. If it fails under conditions other than those covered will be repaired at the current price of parts and labor in effect at the time of repair. Such repairs are warranted for six (6) months from the day of reshipment to the buyer.

4. Preface

Dear Users,

The 4x2 DP Dual Monitor KVM Switch allows for efficient streamlining of cross-platform computer systems while simplifying multi-device management. It supports control of a dual-display multimedia workstation. By connecting all two video outputs from a single PC to one of the KVM's input groups, you can achieve an extended or mirrored desktop across two monitors, replicating the experience of a direct connection. Additionally, the KVM allows you to view multiple PCs across the two monitors simultaneously.

Equipped with USB 3.2 Gen 1 (5 Gbps) SuperSpeed technology for SuperSpeed data transfer and support for resolutions up to 8K@60Hz, this KVM switch delivers ultra-clear visuals with vibrant, true-to-life colors and high-fidelity audio. You can switch between input ports using the front-panel buttons, IR remote, mouse scroll wheel, or keyboard hotkeys. Customizable hotkeys and peripheral pairing further enhance seamless cross-platform control.

Tips: If you need to control more computers or conduct more complex and professional switching, you can also choose other products of our company. For more details, please visit our official website: www.tesmart.com.

5. Features

- Using 2 monitors, 1 set of keyboard and mouse to control 4 computers
- Support resolution up to 8K(4320p)@60Hz and is backward compatible with 4K(2160p)@60Hz/120Hz/144Hz
- DisplayPort 1.4 compliant
- Support 2 display modes
- Support Unix/Windows/ Debian/ Ubuntu/Fedora/ MacOS X/ Raspbian/ Ubuntu for Raspberry Pi and other Linux based systems
- Support USB 3.2 Gen 1 with super-speed data transfer rate
- Support hot plug, disconnect or connect devices to the KVM at any time without turning off PC
- With EDID emulator in each input port, it can keep PCs always having correct display information
- Support IR signals, front panel button, mouse wheel and keyboard hot keys to control the KVM to switch input ports
- Keyboard and mouse support passthrough mode and legacy emulation mode, significantly improving compatibility for keyboards and mouses

6. Packing List

- 1 * 4x2 DP Dual Monitor KVM Switch
- 4 * USB 3.0 Cables
- 8 * DP Cables
- 1 * IR Remote Control
- 1 * IR Receiver Cable
- 1 * DC 12V Power Adapter
- 1 * User Manual
- 2 * Rack-ears

Tips: After receipt of the product, please check the packing list carefully to make sure that no components have been lost and no damage to the product has been caused during transportation. If you have any problem, please contact us at any time.

7. Panel Description

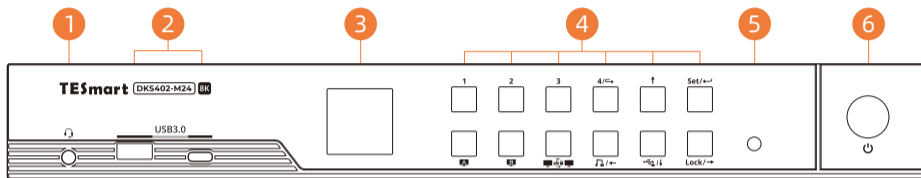

ID	Name	Function
1	3.5mm Audio/Mic	Integrated microphone and L/R audio output.
2	USB 3.2 Gen 1 ports	Can be used to transfer data and charge your mobile devices.
3	LCD	Display current status and function settings.

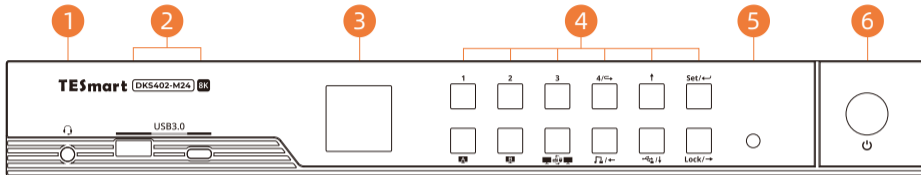

ID	Name	Function
4	Keypad	Press to control the KVM. Please refer to Chapter 10.1 for the detail.
5	IR receiver	Receive IR remote signal.
6	Power switch	Turn on or turn off power supply.

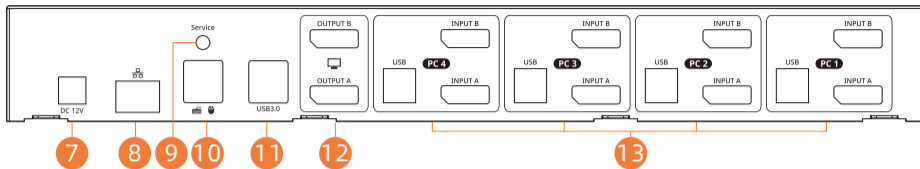

ID	Name	Function
7	DC 12V	12V DC power supply.
8	LAN port	Insert the network cable into this port to let the 4 input PCs to connect to the local network area.
9	UART command interface or IR receiver cable in	Support external UART commands for channel switch and functionality control or connect IR extension cable to this port to receive IR signal.
10	Keyboard and mouse input	For USB keyboard and mouse input.

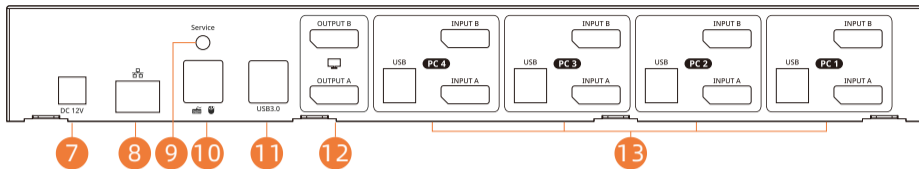

ID	Name	Function
11	USB 3.2 Gen 1 ports	Connect to USB 3.0 device.
12	DP outputs	Connect to 2 DP displays for video output.
13	KVM input ports group	4 PCs can be connected to the KVM at the same time. Each group contains 2 DP ports(marked as Input A/B) and 1 USB port. Connect the ports to corresponding input devices for signal input.

8. Connection Description

8.1 Connection Diagram

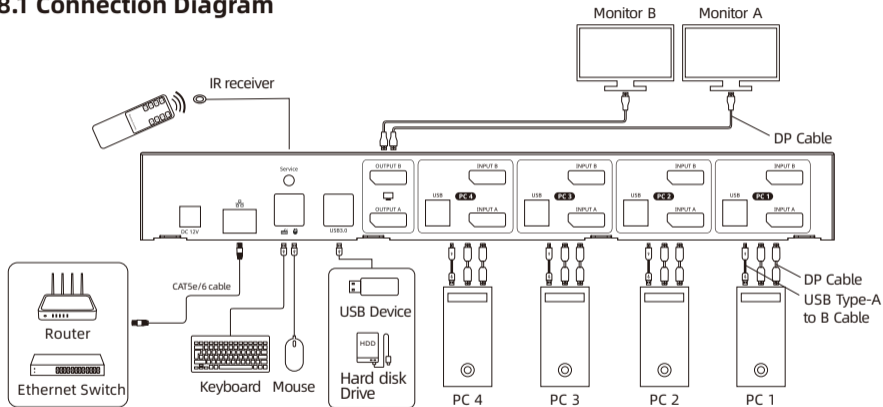

Tips: For your better use of this product, we recommend that you connect all the input ports on each KVM input port group to the same PC.

8.2 Connection Preparation

- Take into consideration all devices required to be connected and prepare a workbench large enough before the connection.
- Lay out the cables properly to facilitate the layout of power supply as a lot of power sockets and plug boards will be adopted in connection.
- Prepare different sticker labels to mark cables as a lot of cables will be adopted in connection.

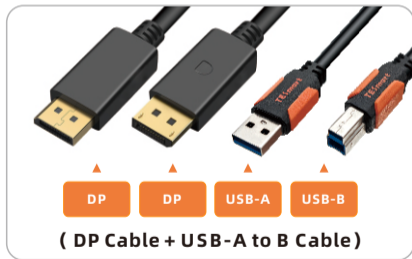

8.3 Connection Steps

1. Connect it using two DisplayPort cables and one USB-A-to-B cable. Connect the two DisplayPort cables from the PC to a single DP port group on the KVM switch. Then, connect the USB-B end of the USB cable to the corresponding USB-B port within the same port group on the KVM, and the USB-A end to the PC. Repeat this process in the same way for PCs 2 to 4, ensuring each PC is connected to its own dedicated port group.



2. Connect KVM's DP output ports to 2 DP displays with 2 DP cables.



3. Connect external mouse and keyboard to KVM's keyboard and mouse input port.



4. Connect USB 3.0 devices to KVM's standard USB 3.0 ports.



5. Connect external audio device to KVM's L/R out port.

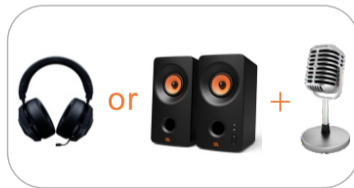

6. Connect the KVM's RJ45 port to a switch or router using a network cable.



7. Connect the power cable to KVM's DC 12V port and plug it to a power socket.



8. By now, the connection has been completed. Turn on the power supply and the KVM Switch will begin to work.

9. Function Description

9.1 Display Mode Description

The 4x2 DP KVM Switch supports 2 display modes. You can choose to implement 2-screen extended display or duplicate display or display different PCs on 2 monitors.

Display Mode 1: Display the same PC

Duplicate displays

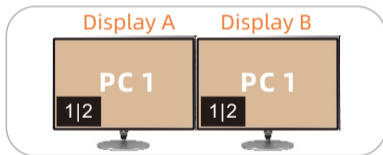

Extend displays

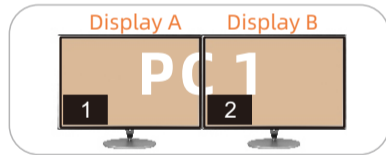

- Tips:**
1. You can set the duplicate or extend displays in the Display Settings of the current selected PC.
 2. Only when 2 video ports of the same PC are connected to Input A and Input B of a group of input ports at the same time, can duplication or expansion of two screens be realized.

8.4 KVM Workbench

A workbench with 4x2 DP Dual Monitor KVM Switch successfully connected is shown as below:



Display Mode 2: Display the different PCs

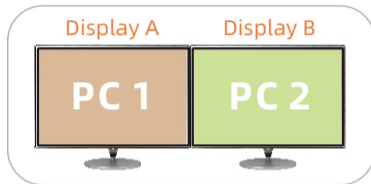

In this mode, you can show one PC on any of two monitors connected to the KVM and the other PC on the remaining monitor. Use the front panel, keyboard hotkeys, or IR control to switch between PCs and monitors.

Tips: When different PCs are displayed on different monitors, you can double-click the **Right-[Alt]** on the keyboard connected to the KVM to switch the keyboard and mouse focus between different PCs.

9.2 EDID Emulator

Our 4x2 DP KVM Switch with EDID emulators in each input port, keeping PCs always having correct display information. And the KVM will maintain EDID before and after switching, ensure that the window you open stays in the fixed place. Use the hot key command can enable or disable EDID emulators. The EDID emulators are enabled by default.

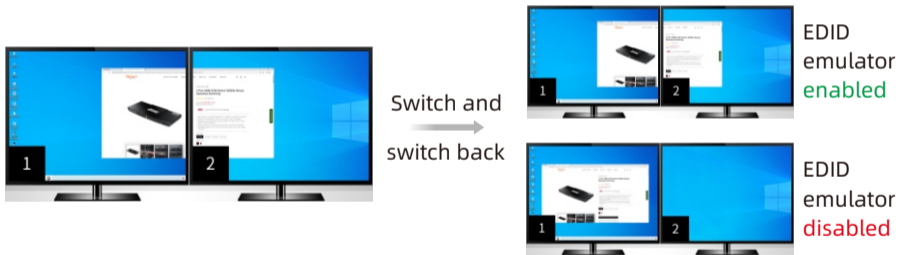

Tips: 1. For your better experience, please keep the EDID emulator enabled. If you encounter some display issues when using the KVM, please disable the EDID emulator and try again.
2. The EDID emulator can be disabled. Please refer to Page 36 for the operating instructions.

9.3 Keyboard and Mouse Emulation Mode

We provide two keyboard and mouse modes: Pass Through Mode and Legacy Emulation Mode. Pass Through mode supports most keyboard and mouse drivers and multifunction keyboards and mice. Legacy Emulation Mode ensures the normal functioning of the keyboard, mouse, and hotkey features.

- Typically, we recommend using Passthrough Mode for an optimal user experience, allowing you to:



If you encounter issues with the keyboard and mouse in Passthrough Mode, we recommend switching to Legacy Emulation Mode.

- Tips:**
1. To toggle between two modes, please refer to Page 36. After toggled, please restart the KVM.
 2. In Legacy Emulation Mode, the keyboard and mouse control software will no longer be available.

9.4 Built-in Network Switch

The 4x2 KVM Switch have a built-in USB Ethernet Adapter, which adds a standard RJ45 port to all the PC that is connected to the KVM and allows you to connect your computers to a router or network switch for gigabit wired network connection. Full 1000Mbps Ethernet for fast, stable data transfer, more reliable than most wireless connections. This feature has been added with a switch, allowing you to freely choose to enable or disable it.

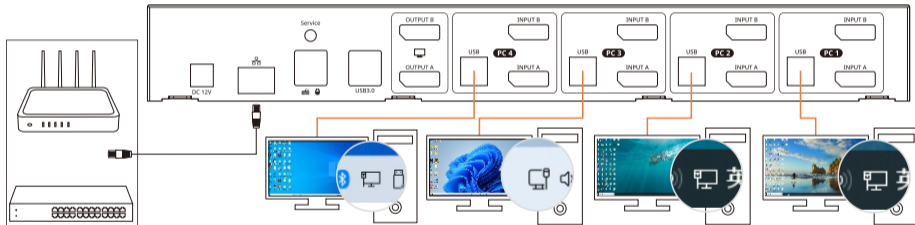

- Tips:**
1. It is recommended to connect the USB cable to a USB 3.0 or higher port on the PC to achieve a Gigabit bandwidth network connection.
 2. The built-in network switch can be disabled separately. Please refer to Page 36 for the operating instructions.

9.5 Lock L/R Audio and USB Focus Function

The 4x2 DP KVM Switch supports locking L/R audio and USB 3.0 focus. After the lock is turned on, the current audio or USB focus can be maintained and only the screen can be switched when switching; the audio focus lock and USB 3.0 focus lock are independent of each other, you can lock the audio or lock the USB separately. Only need to press the front panel keys to operate audio or USB focus lock.

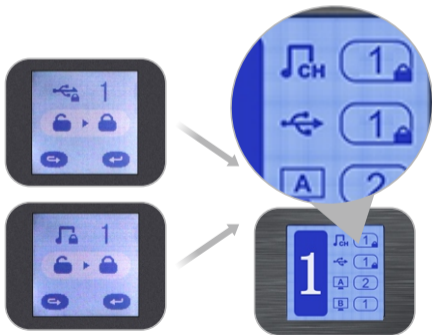

- Tips:**
1. The keyboard & mouse focus and USB focus are independent of each other, and the keyboard and mouse focus cannot be locked. When switching between different input sources in display mode 2, the keyboard and mouse focus will not change with the switch.
 2. The lock state is maintained after the KVM is powered off.
 3. Please refer to Chapter 10.1 for detailed information about how to lock/unlock audio or USB.

9.6 Auto Scan Mode Description

The Auto Scan feature can automatically switch the display at regular intervals between the input devices . As a result, any input devices connected to each port can be monitored without user intervention. Auto scan mode is off by default. You can turn on the auto scan mode through the front panel keypad and keyboard hot key.

After the auto scan mode is turned on, the lower left corner in the main menu interface of the LCD will appear a white 'SCAN'.



- Tips:**
1. When auto scan mode is turned on, regardless of the current routing status, all monitors will display PC 1 at first. When scanning, switch in the order of PC 1-4, and all displays will display the same PC every time it switches.
 2. Please refer to Chapter 10 for detailed information about how to turn on/off the auto scan mode.

9.7 Mouse Wheel Switching

Mouse wheel switching method can quickly switch input sources by mouse operation, double-click the mouse wheel to switch to the next input port. Mouse wheel switching mode is off by default. You can use keyboard hotkey command to turn on mouse wheel switching mode. Please refer to Page 37.

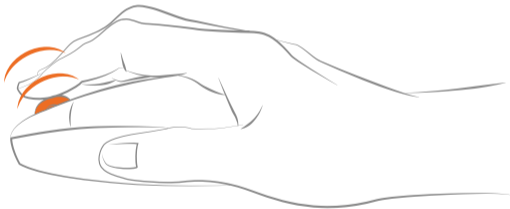

9.8 Built-in Charging Module

The 4x2 DP KVM switch has a built-in charging module, allowing you to safely charge your phone, tablet and other devices. With two front-panel USB ports (including an USB-A port and an USB-C port), it supports data transmission while charging.

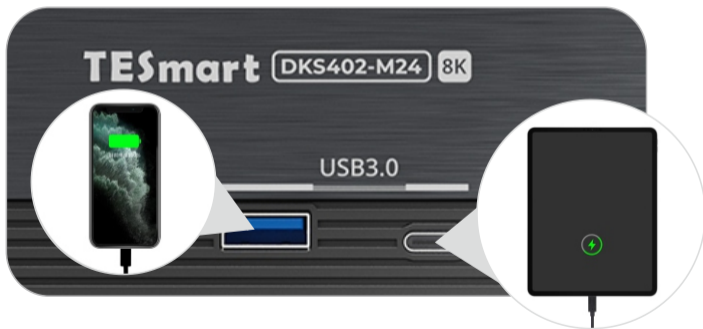











10. Operation Method

10.1 Front Panel Button Switching Method



When you use the front panel button or IR remote to control the KVM, the LCD display will inquiry your target action, then execute the command according to your operation. The LCD interface in the figure above is the main interface.

Schematic table of LCD interface and panel icons:

Icons	Meaning and function		
	Monitor A and B.		
	Audio focus icon, indicating the PC where the external audio focus is currently located.		
	USB focus icon, indicating the PC where the external USB 3.0 device focus is currently located.		
	Keyboard and mouse focus icon, indicating the PC where the keyboard and mouse focus is currently located.		
	Audio lock icon, indicating that the current audio is locked on the PC corresponding to the number behind the  icon on the main interface.		
	USB lock icon, indicating that the current USB 3.0 devices are locked on the PC corresponding to the number behind the  icon on the main interface.		
	keyboard and mouse focus switch button, press to switch keyboard and mouse focus between displayed PCs in display mode 2.		
	Return button.		Enter button.

**1~4 button:**

1. Press directly to switch among 4 PCs. After switching, 2 displays will display the selected PC at the same time, i.e. display mode 1.
2. In the settings interface, press [**4 / \leftrightarrow**] to return to the main interface.

**Display selection button:**

Directly press the button, then press the [**1~4**] buttons according to the prompt of the LCD screen to make the selected monitor display the selected PC. i.e. display mode 2.

Tips: For example, if you press the combo like 'A-1', 'B-4', the image of channel 'Input A' of PC 1 will be displayed on the Output A, the image of channel 'Input B' of PC 4 will be displayed on the Output B. The operation on the IR remote control are the same.

**Keyboard and mouse focus switch button:**

Directly press to switch keyboard and mouse focus between displayed PCs in display mode 2.

**Audio lock button:**

1. Directly press [**♪ / \leftarrow**] button, follow the prompts on the LCD screen, then press the [**Set / \leftarrow**] button to lock the L/R audio to the current PC. Any operation after locking will not change the locked state. Press the key again in the locked

state, and then press the [Set / ←] button to unlock.

2. In the menu and setting interface, press [⏪ / ←] button to page forward or select to the left.



USB lock button:



1. Directly press [⏪ / ↓] button, follow the prompts on the LCD screen, then press the [Set / ←] button to lock the external USB 3.0 devices to the current PC. Any operation after locking will not change the locked state. Press the key again in the locked state, and then press the [Set / ←] button to unlock.
2. In the settings menu, Press [⏪ / ↓] button to select down.



Select up button:

In the settings menu, Press [↑] button to select up.



Settings button:

1. Press the button, according to the LCD screen prompts, you can set up **auto scan mode and auto scan time**, **enable or disable EDID emulator and buzzer**, **set hotkey trigger key**, **set network status**, **set screen brightness**, **change password**, **Factory reset**, in the menu. Use the [←][→] key to select among different options under each setting.
2. In the menu and setting interface, press [Set / ←] button to confirm.

- Tips:** 1. Only numbers 1,2,3,4 on the front panel of the KVM are available when changing PIN. You can also set a PIN to null to unlock without a password.
2. Under the PIN modification interface, the button [🎵 / ←] is used as the return button.



Lock / →

Lock button:

1. Press [Lock / →] button to lock the KVM. After locking, all displays will be off, audio output will be paused, and LCD screen brightness will be reduced to a minimum, all buttons will be invalid. Press [Lock / →] button again to light up the LCD screen, then enter the PIN to unlock.
2. In the menu and setting interface, press [Lock / →] button to page backward or select to the right.

- Tips:** 1. You can reset your PIN in settings menu.
2. If you forget your PIN, you can restore the factory default settings to unlock. The default PIN is 1234. Press and hold the [Lock / →] for about 10 seconds to restore the factory default settings.
3. IR remote control and keyboard hot keys are invalid when KVM is locked.

Tips: The setting status in the interface is automatically synchronized with the current settings, and the selected option is indicated by the dark color.

10.2 IR Remote Control

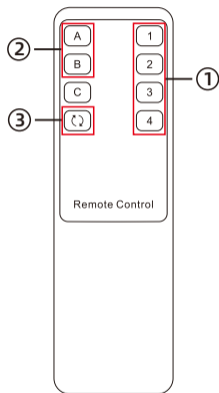

- ① — Press directly to select among 4 PCs, and 2 displays will display the selected PC at the same time. (i.e. display mode 1)
- ② — Press the key, and then press the [1~4] key to make the selected monitor display the selected PC. (i.e. display mode 2)
- ③ — Switch to the next input port

Tips: Unspecified buttons at above are non-functional.

10.3 Keyboard Hot Keys

- Use external keyboard hot keys to switch the input source or set up some other functions..

Tips: The keyboard hot keys can only work with external keyboard correctly connected to the keyboard and mouse input port of the KVM.

After press **[Right-Ctrl]** key twice within 2 seconds then please enter the commands within 3 seconds and the KVM will execute the corresponding commands.

Select previous input port:

[Right-Ctrl]→[Right-Ctrl]→[PgUp]



Select next input port:

[Right-Ctrl]→[Right-Ctrl]→[PgDn]



Select port by port number(i.e. display mode 1):

[Right-Ctrl]→[Right-Ctrl]→[1]~[4]



Switch PCs on different monitors separately(i.e. display mode 2):

Monitor A: [Right-Ctrl] → [Right-Ctrl] → [←] → [1]~[4]



Monitor B: [Right-Ctrl] → [Right-Ctrl] → [→] → [1]~[4]



Switch keyboard and mouse focus in display mode 2: [Right-Alt] → [Right-Alt]



Turn on auto scan mode:

[Right-Ctrl] → [Right-Ctrl] → [Space]



Tips: The default auto scan time interval is 5 seconds. You can change the time interval by following the step presented below.

Increase or decrease auto scan time interval:

[Right-Ctrl] → [Right-Ctrl] → [+] / [-]



Tips: This hot key command can only work while the auto scan mode is activated. Press [Right-Ctrl] twice and keep pressing [+]/[-] key to adjust the time interval continuously. Increase or decrease 1 second at one time.

Press [Esc] to exit auto scan mode.



Tips: Enabling the auto scan mode will trigger the buzzer to beep twice and disable it will trigger the buzzer to beep once.

Toggle between keyboard and mouse modes:
[Right-Ctrl] → [Right-Ctrl] → [F2]



Tips: The default keyboard and mouse mode is Pass Through mode. After toggled, please restart the KVM. When switching to Compatibility Mode, the buzzer will emit 2 short beeps; when switching to Pass Through Mode, the buzzer will emit only 1 short beep.

Toggle the on/off status of the currently displayed PC's integrated network adapter:
[Right-Ctrl] → [Right-Ctrl] → [F4]



Tips: The integrated network adapter is enabled by default. It can be disabled separately. Enable it will trigger the buzzer to beep twice and disable it will trigger the buzzer to beep once.

Disable/enable EDID emulator:
[Right-Ctrl] → [Right-Ctrl] → [F5]



Tips: The EDID emulator is enabled by default. Enable it will trigger the buzzer to beep twice and disable it will trigger the buzzer to beep once.

Turn on/off mouse wheel switching mode:

[Right-Ctrl] → [Right-Ctrl] → [F6]



Tips: Turning on the mouse wheel switching mode will trigger the buzzer to beep twice and turning it off will trigger the buzzer to beep once.

Disable or enable buzzer sound:

[Right-Ctrl] → [Right-Ctrl] → [F11]



Tips: The default setting of buzzer sound is enabled. Disable buzzer sound will trigger the buzzer to beep once and enable it will trigger the buzzer to beep twice.

11. Change Hot Key Combinations

For your convenience, we have built-in a custom hotkey function. By setting, you can use any key on the keyboard connected to the KVM as the trigger key for the hot key command. The default hotkey trigger key is the **[Right-CTRL]**. The custom hotkey function can be set in the following ways:

Method 1:

- Change the hot key through the settings in the LCD menu, press the **[Set / ←]** key and find the "Hot key" option to set. When starting to set the trigger key, the buzzer will have a 5 seconds tone. Please press the key you want to use as the hot key trigger key on the keyboard within 5 seconds. After pressing the button, the prompt tone ends and the setting is complete.

Method 2:

- Press **[Right-Ctrl]→[Right-Ctrl]→[F1]**, then the buzzer will have a 5 seconds tone. Please press the key you want to use as the hot key trigger key on the keyboard within 5 seconds. After pressing the button, the prompt tone ends and the setting is complete.



TESmart

To Enjoy Smart

DKS402 Master 24

TESmart Tech Co.,Ltd

CE FC   **HDCP** **HDMI**
TM

WEEE-Reg.-Nr. DE 66784279