

TESmart

**User 4x2 Dual Monitor
Manual KVM Switch**



HK50402A2U

To Enjoy Smart

HK50402A2U

English



English



Preface

It's our great honor that you have chosen the KVM Switch produced by our company, Tesla Elec Technology Co.,Ltd. In this user manual, you will learn how to operate and use this product. Please read this user manual comprehensively before use. If you have any questions, comments or suggestions, please contact us via the following email:

support@tesmart.com.

Copyright Notice

The user manual, compiled by Tesla Elec Technology Co.,Ltd, shall not be duplicated or translated by any person or organizations without written permission. This user manual shall not be used for commodity transaction in any form or by any means (electronically, mechanically, photocopying or recording, etc.) or be used for any business practices or profitable activities. The ownership of the trade names and brand names adopted in this user manual belongs to their companies.

Address of Manufacture

Tesla Elec Technology Co.,Ltd 2F,
Building C, Xingzhisheng Industrial Park, No.12,
Xiawei Industrial Zone, Zhangkengjing Road,
Guanlan Street,
Longhua District, Shenzhen City,
Guangdong Province, China

Contents

1. Safety Tips and Warnings	01	9.4 Auto Scan Mode Description	
2. Battery Description.....	02	9.5 Mouse wheel Switching	
3. Warranty Information.....	03	10. Operation Method.....	22
4. Preface.....	04	10.1 Front Panel Button Switching Method	
5. Features.....	05	10.2 IR Remote Control	
6. Packing List.....	06	10.3 Keyboard Hot Keys	
7. Panel Description.....	07	11. Change Hot Key Combination.....	31
8. Connection Description.....	09	12. Pass Through Mode Description.....	32
8.1 Connection Diagram		12.1 Introduction of Pass Through Mode	
8.2 Connection Preparation		12.2 Keyboard and Mouse Compatible Model List	
8.3 Connection Steps			
8.4 KVM Workbench			
9. Function Description.....	16		
9.1 Display Mode Description			
9.2 Built-in charging module			
9.3 Lock L/R Audio and USB Focus Function			

1. Safety Tips and Warnings

Tips: Please read the safety tips and warnings for KVM Switch comprehensively before use. Use this produce in accordance with its instructions, safety tips and warnings to prevent unnecessary damage to the product and potential dangers to users.

- ⚠ Keep the product away from water.
- ⚠ Clean the product with dry cloth.
- ⚠ Use the product in accordance with its instructions and do not block its vents.
- ⚠ Keep the product away from ignition sources, such as heat sinks, heat accumulators, stovepipes and other heat production settings (including audio amplifiers).
- ⚠ Do not touch the product and the power cord with wet hands so as to lower the risk of electric shock and damage to the product. Do not let the product get wet or become damp.
- ⚠ Unplug the power supply of this product in thunderstorm days or when it has been not used for a long time.
- ⚠ Do not expose this product and its battery to open fire or overheating environment. Dispose the waste battery in accordance with instructions.
- ⚠ Users shall not remove and repair the product without authorization.

2. Battery Description

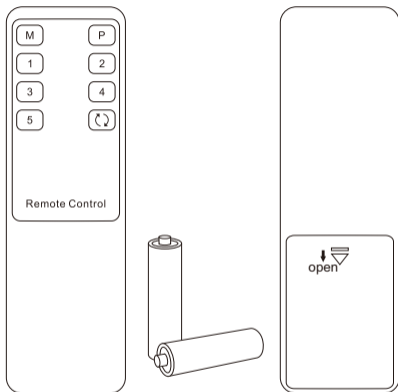

Tips: By default, the remote control is not equipped with batteries, due to the safety requirements of some express companies. Install AAA dry cells before use.

Caution: Improper disposal of the lithium battery may cause an explosion. Do not throw the battery into fire. Keep the battery away from children. Dispose the waste battery in accordance with local regulations.



3. Warranty Information

We warrant this product as free of defects in material and workmanship for a period of one (1) year from the date of shipment. If during the period of warranty this product proves defective under normal use, we will repair or replace this product, provided that this product has not been subjected to mechanical, electrical, or other abuse or modifications. If it fails under conditions other than those covered will be repaired at the current price of parts and labor in effect at the time of repair. Such repairs are warranted for six (6) months from the day of reshipment to the buyer.

4. Preface

Dear Users,

4x2 HDMI KVM Switch can easily integrate cross-platform computer devices and greatly simplify the devices management. Support managing a dual-display multimedia workstation. If you connect 2 video ports of the same PC to 1 group of input ports on the KVM, you will realize 2-screen extended display or copy display. It has the same effect as connecting the PC directly to 2 displays. The KVM also supports displaying different PCs on 2 monitors.

This KVM support USB 3.0 ports with superspeed data transfer rate. With USB charge ports on the front panel, support BC 1.2 protocol to charge devices like mobile phones and tablets. At the same time, with EDID emulators in each input port, it can keep PCs always having correct display information.

Tips: If you need to control more computers or conduct more complex and professional switching, you can also choose other products of our company. For more details, please visit our official website: www.tesmart.com.

5. Features

- Using only 1 set of keyboard, mouse and 2 monitors to control 4 PCs
- Support 2 display modes
- Support Unix/Windows/Debian/Ubuntu/Fedora/Mac OS X/ Raspbian/Ubuntu for Raspberry Pi and other Linux basic system
- Support resolution up to 3840*2160@60Hz
- Support front panel button, keyboard hotkeys, mouse wheel and IR remote control to control KVM
- Available to use keyboard and mouse without any delay after switching input sources
- Support USB 3.0 port with super-speed data transfer rate
- Support keyboard and mouse pass through mode to improve KVM compatibility
- Support auto scan to monitor computers in a specified time interval
- With EDID emulators in each input port, keep PCs always having correct display information
- Support charging the devices like mobile phones and tablets connected to front panel USB ports

6. Packing List

- 1 * 4x2 HDMI KVM Switch
- 4 * KVM Cables
- 4 * HDMI Cables
- 1 * IR Extension Cable
- 1 * IR Remote Control
- 1 * DC 12V Power Adapter
- 1 * User Manual
- 2 * Rack-ears

Tips: After receipt of the product, please check the packing list carefully to make sure that no components have been lost and no damage to the product has been caused during transportation. If you have any problem, please contact us at any time.

7. Panel Description

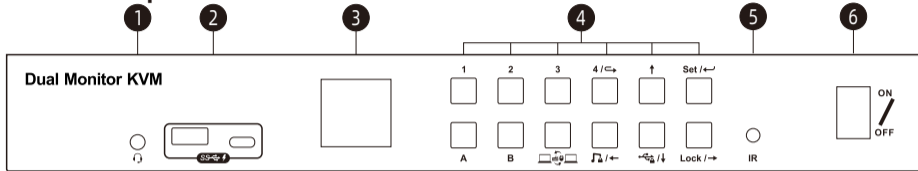

ID	Name	Function	ID	Name	Function
1	Audio integration port	Integrated microphone and L/R audio output.	2	Data transfer and charging port	Can be used to transfer data and charge your mobile devices.
3	Color LCD	Display current status and function settings.	4	Keypad	Press to control the KVM. Please refer to Chapter 10.1 for the detail.
5	IR receiver	Receive IR remote signal.	6	Power switch	Turn on or turn off power supply.

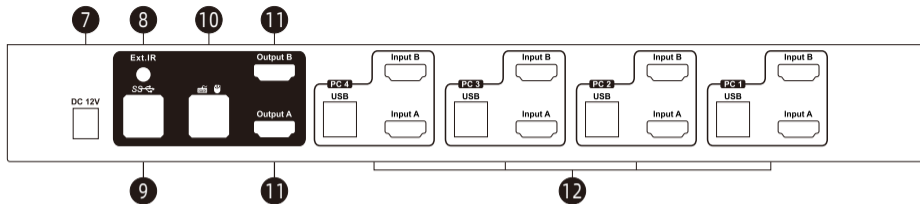

ID	Name	Function	ID	Name	Function
7	DC 12V	12V DC power supply.	8	IR extension in	Connect IR extension cable to this port to receive IR signal even the KVM is installed in a rack.
9	USB 3.0 port	Connect to USB 3.0 device.	10	Keyboard and mouse port	For USB keyboard and mouse input.
11	HDMI outputs	Connect to 2 HDMI displays for video output.	12	KVM input ports group	Each group contains 2 HDMI ports and a USB port. Connect the ports to input devices for signal input.

8. Connection Description

8.1 Connection Diagram

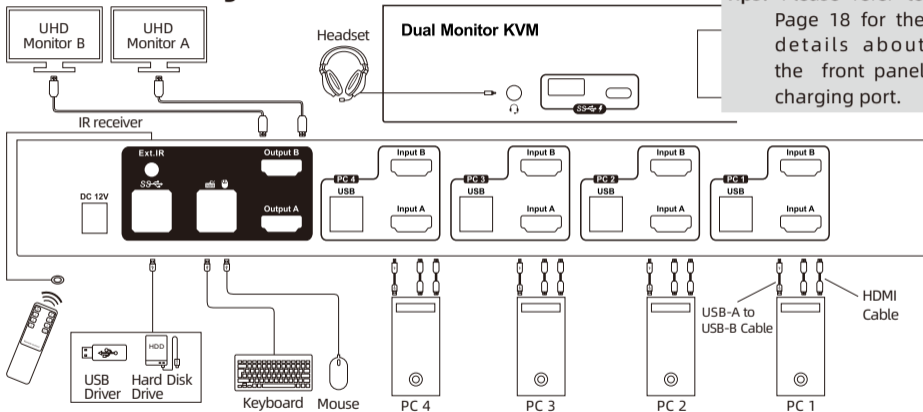

Tips: Please refer to Page 18 for the details about the front panel charging port.

Tips: For your better use of this product, we suggest you connect each group port on the KVM to the same PC.

8.2 Connection Preparation

- Take into consideration all devices required to be connected and prepare a workbench large enough before the connection.
- Lay out the cables properly to facilitate the layout of power supply as a lot of power sockets and plug boards will be adopted in connection.
- Prepare different sticker labels to mark cables as a lot of cables will be adopted in connection.

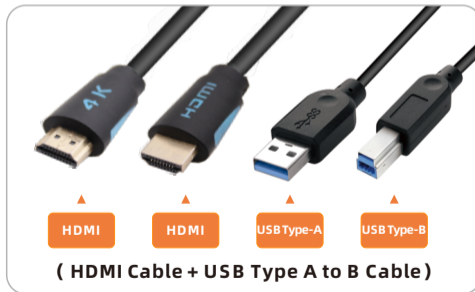

8.3 Connection Steps

1. Connect PC1 with 1 KVM cable and 1 HDMI cable, use HDMI end to connect PC1 to the corresponding HDMI ports group on the KVM, use USB-A end to connect each PC and USB-B end to connect the KVM.



2. Connect PC2~4 in the same way as shown above.

3. Connect external mouse and keyboard to KVM's keyboard and mouse input port.

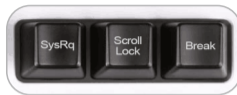

Tips: For the normal service of hotkeys, we recommend you use the full-key external keyboard with a separate [Scroll Lock] key (as shown above).

4. Connect USB 3.0 devices to KVM's standard USB 3.0 ports.



5. Connect KVM's HDMI output ports to 2 HDMI displays with 2 HDMI cables.



7. Connect external audio devices to KVM's L/R out ports.

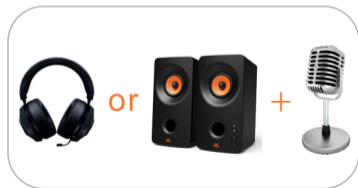

8. Connect the power cable to KVM's DC 12V port and plug it to a power socket.



9. By now, the connection has been completed. Turn on the power supply and the KVM Switch will begin to work.

8.4 KVM Workbench

A workbench with 4x2 HDMI KVM Switch successfully connected is shown as below:



9. Function Description

9.1 Display Mode Description

The 4x2 HDMI KVM Switch support 2 display mode. You can choose to implement 2-screen extended display or duplicate display or display different PCs on 2 monitors.

Display Mode 1: Display the same PC

Duplicate displays

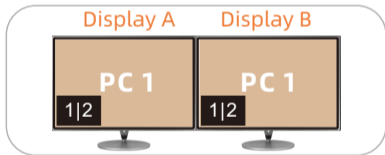

Extend displays

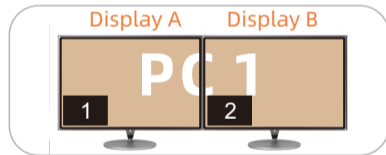

- Tips:**
1. You can set the duplicate or extend displays in the Display Settings of the current selected PC.
 2. Only when 2 video ports of the same PC are connected to Input A and Input B of a group of input ports at the same time, can duplication or expansion of two screens be realized.

Display Mode 2: The mixed mode

Two monitors respectively show the desktop of two PCs.

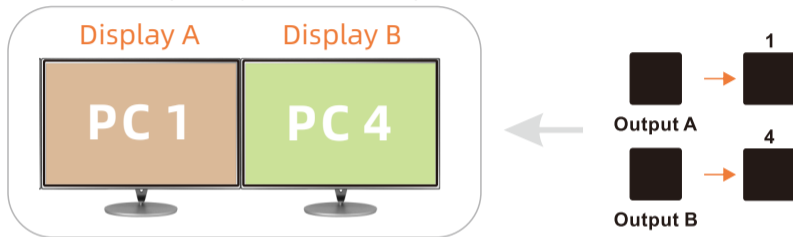

Tips: The main screen and the extend screen cannot be interchanged through the KVM on any display mode. That is to say, the image of any 'Input A' cannot be displayed on 'Output B', vice versa. If you want to change the setting, please set in the PC Display Settings manually.

When different PCs are displayed on different monitors, you can double-click the **Right-[Alt]** on the keyboard connected to the KVM to switch the peripheral device focus between different PCs.

9.2 Built-in charging module

The 4x2 HDMI KVM Switch has built-in charging module which can charge your phone, tablet and other devices. Use the 2 USB ports on the front panel of the KVM (including an USB-A and an USB-C ports) can support data transmission while charging. The charging ports support BC 1.2 protocol, and is able to match voltage and current automatically based on the specifications of charging devices. It makes your charging safe and avoid damage.



9.3 Lock L/R Audio and USB Focus Function

The 4x2 HDMI KVM Switch supports locking L/R audio and USB 3.0 focus. After the lock is turned on, the current audio or USB focus can be maintained and only the screen can be switched when switching; the audio focus lock and USB 3.0 focus lock are independent of each other, you can lock the audio or lock the USB separately. Only need to press the front panel keys to operate audio or USB focus lock.

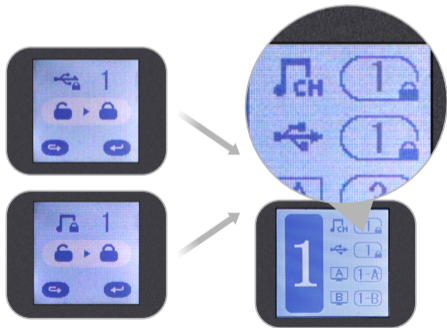

- Tips:**
1. The keyboard & mouse focus and USB focus are independent of each other, and the keyboard and mouse focus cannot be locked. When switching between different input sources in display mode 2, the keyboard and mouse focus will not change with the switch.
 2. The lock state is automatically released after the KVM is powered off.
 3. Please refer to Chapter 10.1 for detailed information about how to lock/unlock audio or USB.

9.4 Auto Scan Mode Description

The Auto Scan feature can automatically switch the display at regular intervals between the input devices that are powered on and connected to the KVM. As a result, any input devices connected to each port can be monitored without user intervention. Auto scan mode is off by default. You can turn on the auto scan mode through the front panel keypad, keyboard hot key, infrared remote control, etc.

After the auto scan mode is turned on, the lower left corner in the main menu interface of the LCD will appear a white "SCAN".



- Tips:**
1. When auto scan mode is turned on, regardless of the current routing status, all monitors will display PC 1 at first. When scanning, switch in the order of PC 1-4, and all displays will display the same PC every time it switches.
 2. Please refer to Chapter 10 for detailed information about how to turn on/off the auto scan mode.

9.5 Mouse Wheel Switching

Mouse wheel switching method can quickly switch input sources by mouse operation, double-click the mouse wheel to switch to the next input port. Mouse wheel switching mode is off by default. You can use keyboard hotkey command [Right-Ctrl] + [Right-Ctrl] + [F6] to turn on mouse wheel switching mode.











10. Operation Method

10.1 Front Panel Button Switching Method



When you use the front panel button or IR remote to control the KVM, the LCD display will inquire your target action, then execute the command according to your operation. The LCD interface in the figure above is the main interface.

Schematic table of LCD interface and panel icons:

Icons	Meaning and function		
	Monitor A and B.		
	Audio focus icon, indicating the PC where the external audio focus is currently located.		
	USB focus icon, indicating the PC where the external USB 3.0 device focus is currently located.		
	Keyboard and mouse focus icon, indicating the PC where the keyboard and mouse focus is currently located.		
	Audio lock icon, indicating that the current audio is locked on the PC corresponding to the number behind the  icon on the main interface.		
	USB lock icon, indicating that the current USB 3.0 devices are locked on the PC corresponding to the number behind the  icon on the main interface.		
	keyboard and mouse focus switch button, press to switch keyboard and mouse focus between displayed PCs.		
	Return button.		Enter button.

**1~4 button:**

1. Press directly to switch among 4 PCs. After switching, 2 displays will display the selected PC at the same time, i.e. display mode 1.
2. In the settings interface, press [4 / ⇄] to return to the main interface.

**Display selection button:**

Directly press the button, then press the [1~4] buttons according to the prompt of the LCD screen to make the selected monitor display the selected PC. i.e. display mode 2.

Tips: For example, if you press the combo like 'A-1', 'B-4', the image of channel 'Input A' of PC 1 will be displayed on the Display A, the image of channel 'Input B' of PC 4 will be displayed on the Display B. The operation on the IR remote control are the same.

**Keyboard and mouse focus switch button:**

Directly press to switch keyboard and mouse focus between displayed PCs.

Audio lock button:

1. Directly press [♪ / ←] button, follow the prompts on the LCD screen, then press the [Set / ←] button to lock the L/R audio to the current PC. Any operation after locking will not change the locked state. Press the key again in the locked

state, and then press the [Set / ←] button to unlock.

2. In the menu and setting interface, press [↵ / ←] button to page forward or select to the left.



USB lock button:

1. Directly press [↵ / ↓] button, follow the prompts on the LCD screen, then press the [Set / ←] button to lock the external USB 3.0 devices to the current PC. Any operation after locking will not change the locked state. Press the key again in the locked state, and then press the [Set / ←] button to unlock.

2. In the settings menu, Press [↵ / ↓] button to select down.



Select up button:

In the settings menu, Press [↑] button to select up.



Settings button:

1. Press the button, according to the LCD screen prompts, you can set up **enable or disable auto scan**, **set auto scan time**, **enable or disable buzzer**, **set hotkey trigger key**, **screen brightness**, **change password**, **factory reset** in the menu. Use the [← →] key to select among different options under each setting.

2. In the menu and setting interface, press [Set / ←] button to confirm.

- Tips:** 1. Only numbers 1,2,3,4 on the front panel of the KVM are available when changing passwords. You can also set a password to null to unlock without a password.
2. Under the password modification interface, the button [🎵 / ←] is used as the return button.



Lock / →

Lock button:

1. Press [Lock / →] button to lock the KVM. After locking, all displays will be off, audio output will be paused, and LCD screen brightness will be reduced to a minimum, all buttons will be invalid. Press [Lock / →] button again to light up the LCD screen, then enter the password to unlock.
2. In the menu and setting interface, press [Lock / →] button to page backward or select to the right.

- Tips:** 1. You can change your password in settings menu.
2. If you forget your password, you can restore the factory default settings to unlock. The default password is 1234. Press and hold the [Lock / →] for about 10 seconds to restore the factory default settings.
3. IR remote control and keyboard hot keys are invalid when KVM is locked.

Tips: The setting status in the interface is automatically synchronized with the current settings, and the selected option is indicated by the dark color.

10.2 IR Remote Control

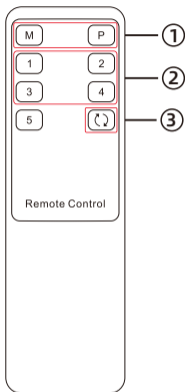

- ① — 1. Press the key [M] or [P] to select the desired monitor, then press the [1~4] button to select the desired PC to make the selected monitor display the selected PC (i.e. the display mode 2)
2. Directly press the key to switch the peripheral device focus to the PC which is displayed on the corresponding monitor currently on display mode 2.
- ② — Directly press the [1~4] key to make the 2 monitors display the selected PC. (i.e. the display mode 1)
- ③ — Directly press to turn on or turn off auto scan mode.

Tips: 1. The key [M] stands for output A, The key [P] stands for output B.
2. The operation when using the IR remote control is the same as using the front panel buttons. If you want to use the IR remote control to switch between different display modes, please refer to the tips on Page 25.
3. Unspecified buttons at above are non-functional.

10.3 Keyboard Hot Keys

→ Use external keyboard hot keys to switch the input source or set up some other functions.

Tips: The keyboard hot keys can only work with external keyboard correctly connected to the keyboard and mouse input port of the KVM.

After press **[Right-Ctrl]** key twice within 2 seconds and you will hear the buzzer beep once, please enter the commands within 3 seconds and the KVM will execute the corresponding commands.

Select previous input port:

[Right-Ctrl]→**[Right-Ctrl]**→**[PgUp]**



Select next input port:

[Right-Ctrl]→**[Right-Ctrl]**→**[PgDn]**



Select port by port number(i.e. the display mode 1):

[Right-Ctrl]→**[Right-Ctrl]**→**[1]~[4]**



Switch PCs on different monitors separately(i.e. display mode 2):

Monitor A: [Right-Ctrl] → [Right-Ctrl] → [←] → [1]~[4]



Monitor B: [Right-Ctrl] → [Right-Ctrl] → [→] → [1]~[4]



Switch focus in display mode 2:

[Right-Alt]→[Right-Alt]



Turn on/off mouse wheel switching mode:

[Right-Ctrl] → [Right-Ctrl] → [F6]



Turn on auto scan mode:

[Right-Ctrl] → [Right-Ctrl] → [Space]



Tips: The default auto scan time interval is 5 seconds. You can change the time interval by setting on the front panel or following the step presented below.

Increase or decrease auto scan time interval:

[Right-Ctrl] → [Right-Ctrl] → [+]/[-]



Tips: This hot key command can only work while the auto scan mode is activated. Press [Right-Ctrl] twice and keep pressing [+]/[-] key to adjust the time interval continuously. Increase or decrease 1 second at one time.

Press **[Esc]** to exit auto scan mode.



Disable or enable buzzer sound:

[Right-Ctrl] → [Right-Ctrl] → [F11]



Tips: The default setting of buzzer sound is enabled. Repeat this step to disable or enable buzzer sound.

11. Change Hot Key Combinations

There are three kinds of trigger hot keys in this product, the default is **[Right-Ctrl]** key, and the alternative are the **[Scroll Lock]** and **[Left-Ctrl]** key. You can switch the hot key to others by:

Method 1:

- Change the hot key through the settings in the LCD menu, press the **[Set /↵]** key and find the "Hot key" option to set.

Method 2:

- Press keyboard hot keys to cyclically switch the control hot key.

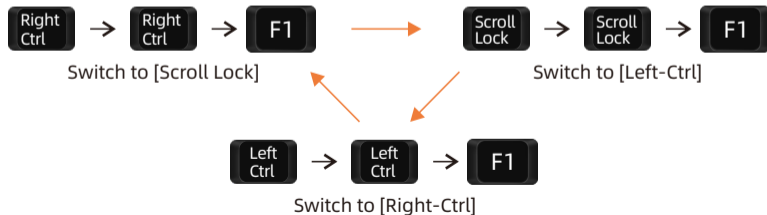

12. Pass Through Mode Description

12.1 Introduction of Pass through mode

Pass through mode is a built-in function of KVM, which is able to improve keyboard and mouse compatibility and enhance user experience. In the pass through mode, the keyboard and mouse are equivalent to directly connecting to the computer. At this time, you can use more keyboard and mouse functions and special functions that are not supported by traditional KVM.

Tips: The current version does not support keyboard and mouse connection via Bluetooth.

12.2 Keyboard and Mouse Compatible Model List

Tips: The following list is from the most representative models of keyboard and mouse that have been tested in the laboratory, mainly from manufacturers with a high market share.

Brand	Model	Brand	Model	Brand	Model	Brand	Model
Aigo	WQ-641	Logitech	G510	Logitech	Marble Mouse	RAPOO	X220
Dell	KB212-B	Logitech	G710	Logitech	Mk540	RAZER	RZ01-0145
Dell	KB522	Logitech	G910	Logitech	Mx1100	RAZER	RC30-021203
Logitech	G105	Logitech	K400PLUS	Logitech	Mx518	Corsair	K55
Logitech	G500S	Logitech	K845	Microsoft	Wireless Desktop 2000	Corsair	K70LUX

TESmart

To Enjoy Smart

HK50402A2U

Tesla Elec Technology Co.,Ltd

CE FC   HDCP 

WEEE-Reg.-Nr. DE 66784279