

TESmert TESmart

User Manual

16x16 HDMI Matrix



HMA1616A20

To Enjoy Smart

HMA1616A20

English

TESmert **TE**Smart



English



Preface

It's our great honor that you have chosen the HDMI Matrix produced by our company, Tesla Elec Technology Co.,Ltd. In this user manual, you will learn how to operate and use this product. Please read this user manual comprehensively before use. If you have any questions, comments or suggestions, please contact us via the following email:
support@tesmart.com.

Copyright Notice

The user manual, compiled by Tesla Elec Technology Co.,Ltd, shall not be duplicated or translated by any person or organizations without written permission. This user manual shall not be used for commodity transaction in any form or by any means (electronically, mechanically, photocopying or recording, etc.) or be used for any business practices or profitable activities. The ownership of the trade names and brand names adopted in this user manual belongs to their companies.

Address of Manufacture









Tesla Elec Technology Co.,Ltd
2F, Building C, Xingzhisheng Industrial Park, No.12,
Xiawei Industrial Zone, Zhangkengjing Road,
Guanlan Street,
Longhua District, Shenzhen City, Guangdong
Province, China

Contents

1. Safety Tips and Warnings	01
2. Battery Description	02
3. Warranty Information	03
4. Preface	04
5. Features	05
6. Packing List	06
7. Panel Description	07
8. Connection Description	09
8.1 Connection Diagram	09
8.2 Connection Steps	10
9. Operation Method	12
9.1 Front Panel Button Switching Method	12
9.2 IR Remote Control	15
9.3 RS232 Control	17

1. Safety Tips and Warnings

Tips: Please read the safety tips and warnings for HDMI Matrix comprehensively before use. Use this produce in accordance with its instructions, safety tips and warnings to prevent unnecessary damage to the product and potential dangers to users.

-  Keep the product away from water.
-  Clean the product with dry cloth.
-  Use the product in accordance with its instructions and do not block its vents.
-  Keep the product away from ignition sources, such as heat sinks, heat accumulators, stovepipe and other heat production settings (including audio amplifiers).
-  Do not touch the product and the power cord with wet hands so as to lower the risk of electric shock and damage to the product. Do not let the product get wet or become damp.
-  Unplug the power supply of this product in thunderstorm days or when it has been not used for a long time.
-  Do not expose this product and its battery to open fire or overheating environment. Dispose the waste battery in accordance with instructions.
-  Users shall not remove and repair the product without authorization.

2. Battery Description

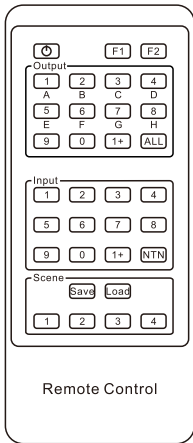

Tips: By default, the remote control is not equipped with batteries, due to the safety requirements of some express companies. Install CR2025 cell before use.

Caution: Improper disposal of the lithium battery may cause an explosion. Do not throw the battery into fire. Keep the battery away from children. Dispose the waste battery in accordance with local regulations.



3. Warranty Information

We warrant this product as free of defects in material and workmanship for a period of one (1) year from the date of shipment. If during the period of warranty this product proves defective under normal use, we will repair or replace this product, provided that this product has not been subjected to mechanical, electrical, or other abuse or modifications. If it fails under conditions other than those covered will be repaired at the current price of parts and labor in effect at the time of repair. Such repairs are warranted for six (6) months from the day of reshipment to the buyer.

4. Preface

Dear Users,

HDMI Matrix can greatly facilitate your management of audio and video devices. If you have multiple sources and display devices like game consoles, streaming boxes, projectors and monitors, our HDMI Matrix can help you match your devices at will. You can choose which output device to display which input device you want, and you can also display one input device on multiple output devices at the same time, eliminating the troublesome of unplugging cables and switching devices, and greatly simplifying the device management.

You can switch input ports with front panel buttons, IR signals, LAN port and RS232 port.

Tips: If you need to control more devices or conduct more complex and professional switching, you can also choose other products of our company. For more details, please visit our official website: www.tesmart.com.

5. Features

- All the HDMI outputs can share same input or select standalone input
- Support resolution up to 3840x2160@ 30Hz
- HDMI 1.4 compliant
- HDCP 1.4 compliant
- Support PCM, Dolby AC3, DTS 5.1 and DSD audio format
- Matrix status could be memorized after power down, automatically restore previous matrix status after next power on
- Smart EDID management, make it compatible with most display devices
- Support 8 configurable user preset connections
- Easy to control matrix via IR receiver, front panel key and PC (via RS232 port or LAN port)

6. Packing List

- 1 * 16x16 HDMI Matrix
- 1 * IR Remote Control
- 1 * IR Extension Cable
- 1 * DC 24V Power Adapter
- 2 * Rack-ears
- 1 * 3 Pins Connector (For RS232)
- 1 * User Manual

Tips: After receipt of the product, please check the packing list carefully to make sure that no components have been lost and no damage to the product has been caused during transportation. If you have any problems, please contact us at any time.

7. Panel Description

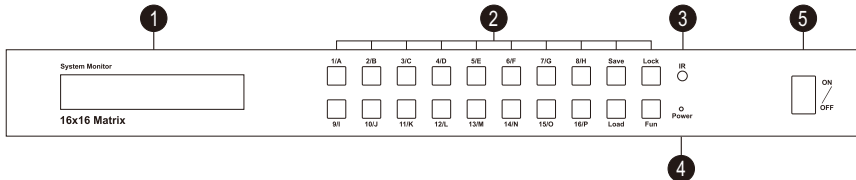

ID	Name	Description
1	LCD display	Display current status and function settings.
2	Keypad	Press to control the Matrix. Please refer to Chapter 9.1 for the detail.
3	IR receiver	Receive IR remote signal.
4	Power status indicator	The LED will be lit (red) if power is on.
5	Power switch	Turn on or turn off power supply.

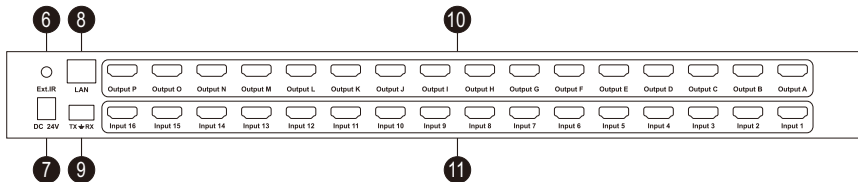

ID	Name	Description
6	IR extension in	Connect IR extension cable to this port to receive IR signal even the Matrix is installed in a rack.
7	DC 24V	DC 24V power supply.
8	LAN port	Connect to control termination to use TCP/IP commands to control the Matrix.
9	RS232 port	Connect to control termination to use RS232 commands to control the Matrix.
10	HDMI output ports	Connect to HDMI display devices.
11	HDMI input ports	Connect to HDMI source devices.

8. Connection Description

8.1 Connection Diagram

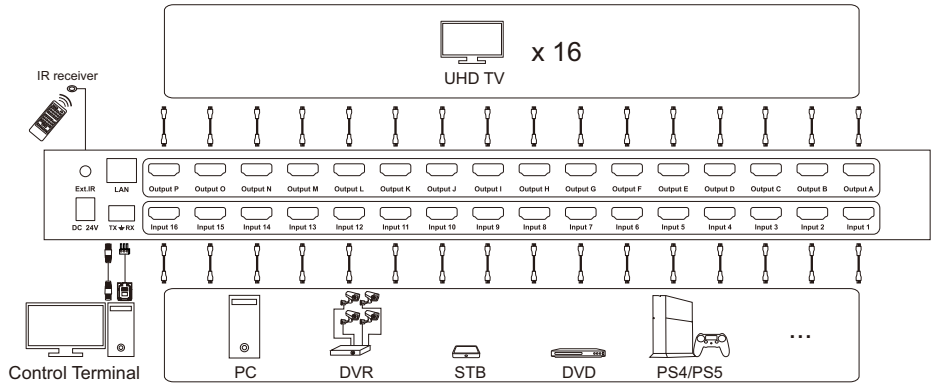

Tips: 1. Please refer to Chapter 9.3 for the detail about LAN port and RS232 port.

8.2 Connection Steps

1. Connect 16 input devices to the HDMI input ports above each "Input" logo of the Matrix using 16 HDMI cables.



2. Connect 16 display devices to the HDMI output ports above each "Output" logo of the Matrix using 16 HDMI cables.



3. Connect the power cable to the HDMI Matrix's DC 24V port and plug it into a power socket.



5. By now, the connection has been completed. Turn on the power supply and the HDMI Matrix will begin to work.

Tips: 1. Please refer to Chapter 9 for detailed information about how to use the HDMI Matrix.
2. By default, the HDMI cables are not included in the package.

9. Operation Method

9.1 Front Panel Button Switching Method



When you use the front panel button or IR remote control to control the Matrix, the LCD screen will inquire your target action, then execute the command according to your operation. On the main menu as shown above, the letters stand for output ports, the numbers stand for input ports.



1/A~16/P buttons:

1. Press once according to the letter to choose the corresponding output port , then press again according to the number to choose the desired input port.
2. If you press the other setting buttons, press the corresponding number button according to LCD prompt to choose the desired option.

Save**Save button:**

Press [Save] button then press any one of [1/A~8/H] button according to LCD prompt to save current routing status to user preset memory 1~8.

**Load****Load button:**

Press [Load] button then press any one of [1/A~8/H] button according to LCD prompt to load routing status from user preset memory 1~8 and apply to current routing.

Lock**Lock button:**

Press [Lock] button to lock or unlock the keypad. If the keypad was locked, all the operations using the keypad or IR remote control would not take effect. Press it again to unlock the keypad when it is locked.

**Fun****Function settings button:**

- 1 to all switch: Press [Fun] button once to select desired input to be displayed on all outputs. Press any one of [1/A~16/P] button according to the number to confirm according to LCD prompt.
2. Mirror connection: After pressing [Fun] button twice, the routing status will be changed to Input 1-Output A, Input 2-Output B, Input 3-Output C, and so on. Press [Lock] button to confirm.



FUN

3. Beep state setting: Press [FUN] button three times to turn off/on the buzzer. Press any one of [1/A~2/B] button to confirm according to LCD prompt.
4. LCD screen timeout setting: Press [Fun] button four times to set the LCD screen time out. Press any one of [1/A~3/C] button to confirm according to LCD prompt.
5. Air fan state setting: Press [Fun] button five times to turn off/on the air fan. Press any one of [1/A~2/B] button to confirm according to LCD prompt.
6. IP address query: Press [Fun] button six times to query current IP address.

Tips: The LCD screen will display the current routing state on loop about every 10 seconds.

9.2 IR Remote Control

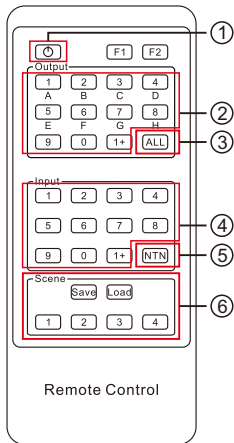

Lock the keypad:

Press the key ① to lock or unlock the keypad. If the keypad was locked, all the operations using the keypad or IR remote control would not take effect. Press it again to unlock the keypad when it is locked.

1 to 1 switch:

Step 1: Press any key in ② to select the output port.

Step 2: Press any key in ④ to select the source which you want to be displayed on selected output.

1 to all switch:

Step 1: Press the key ③ to select all the output ports.

Step 2: Press any key in ④ to select the source which you want to be displayed on all display devices.

Tips: If you need to press 10~16 on the remote control, please press the button '1+' first, then press '0'~'6'. Both input and output also follow this pattern.

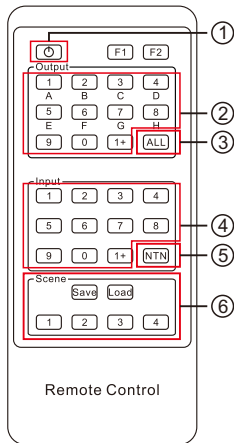

Switch to mirrored connection:

Press the key ⑤, then the routing status will be changed to Input 1 - Output A, Input 2 - Output B, Input 3 - Output C, and so on.

Preset routing for scenes:

Save preset:

Step 1: Press the key **Save** in ⑥.

Step 2: Press any number key in ⑥ to save current routing status to user preset memory 1~4.

Load preset:

Step 1: Press the **Load** key in ⑥.

Step 2: Press any number key in ⑥ to load routing status from user preset memory 1~4 and apply to current routing.

Tips: 1. Unspecified buttons at above are non-functional.

2. Preset routing for scenes function on the remote control only has 4 storage.

9.3 RS232 and LAN Port Control

A. Connect RS232 port

Follow the diagram on the right to connect the standard 9 pin RS232 port to the 3 pins connector which is included in package, then plug the connector to the 'TX' port of the Matrix.

B. Connect LAN port

Follow the diagram on the right to connect the LAN port to local area network router or directly to PC with Cat5e/6 UTP/FTP cable.

C. Communication protocol

RS232 port configuration:

Baud rate: 9600 bps

Stop bit: 1 bit

Data length: 8 bits

Parity bit: None

LAN port default configuration:

IP address: 192.168.1.10

Port: 5000

Gate way: 192.168.1.1

Mask address: 255.255.255.0

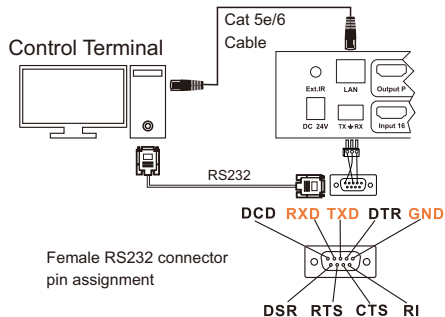

The commands are as the following form:

Index	Command strings	Parameter description	Remark	Direction
1	MT00SW0000NT		Mirrored output 1→1, 2→2, 3→3...	PC→ Matrix
2	MT00SWXX00NT	XX: input port number (01~16)	1 input to all outputs	PC→ Matrix
3	MT00SWXXYYNT	XX: input port number (01~16) YY: output port number (01~16)	Connect input XX to output YY	PC→ Matrix
4	MT00RD0000NT		Request Matrix return current connection status.	PC→ Matrix
5	MT00SV000XNT	X: preset scene number (1~8)	Save current routing status to preset scene number X	PC→ Matrix
6	MT00RD010XNT	X: preset scene number (1~8)	Load status from preset scene number X and apply.	PC→ Matrix

Based on the above commands, we provide a controller on the Windows OS. You can visit our official website to download it: www.tesmart.com

You can also develop dedicated controllers for each platform by referring to the control protocol above.

we provide a controller on the Windows OS. You can visit it: www.tesmart.com

controllers for each platform by referring to the control

D. Matrix Controller Connection steps:

RS232 port usage

Step 1: Use RS232 cable connect PC to the HDMI Matrix.

Step 2: Running the HDMI Matrix Controller.
Select page 'General' and click 'Serial control'.

Step 3: Select the serial communication port number which is connected to the HDMI Matrix.

Step 4: Click 'Connect' to connect to the HDMI Matrix. Then wait until the red indicator beside the button turns green.

Step 5: Select page 'Matrix Control', and click the button to Control the Matrix.

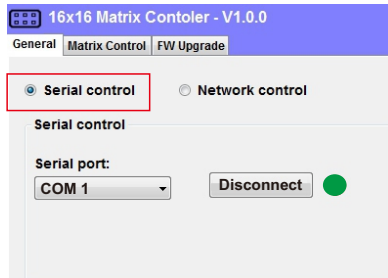

(RS232 serial port
connection successful)

LAN port usage

Step 1: Use Network cable connect PC to the Matrix. Please make sure the PC and the Matrix both on the same network segment.

Step 2: Set the IP address of the network adapter on the PC which is running this software, make sure the IP address is between 192.168.1.2~192.168.1.254 except for 192.168.1.10. Please follow the picture on the next page to set.

Step 3: Running the Matrix Controller. Select page 'General' and click 'Network control'.

Step 4: Click button 'Connect' in network control section, then wait until the red indicator beside the button turns green.

Step 5: After connecting, Select page 'Matrix Control', and click buttons to Control of the Matrix.

Tips: 1. The default IP address is 192.168.1.10. The default port number is 5000.

2. If the connection fails, please check if the Cat cable is connected to the PC, the Matrix is powered on and the IP address setting of the PC is correct.

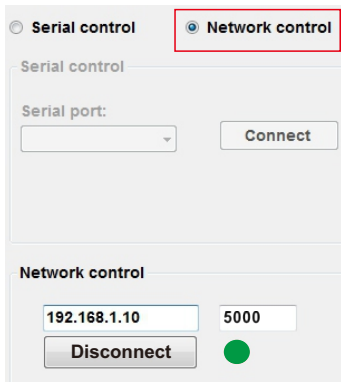

(LAN port connection successful)

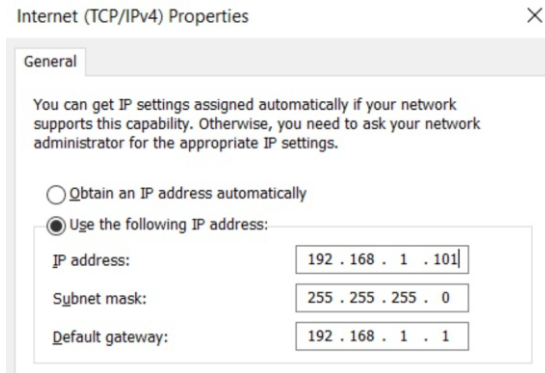

(IP address configuration)

E. Matrix Controller Page Description

Page 'General' :

This page is used to set the parameters to use RS232 commands and the LAN port to connect matrix. Also you can change IP address of the Matrix with the block 3.

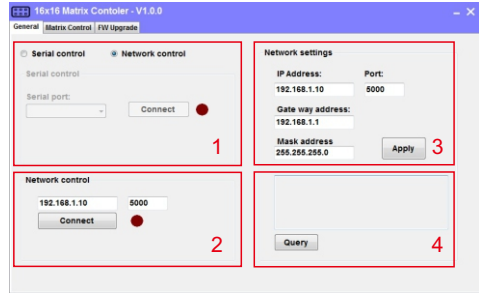

- 1-Serial connect
- 2-Network connect
- 3-Matrix's LAN port settings
- 4-Query current IP configuration

Page 'Matrix Control' :

This page is used for switching and simple system setup. You can conveniently match input and output devices according to your needs.

Output → 1 2 3 4 5 6 7 8 9 A B C D E F G

Input → 0 0 0 0 0 0 0 0 0 0 0 0 0 0 0 0

N to N 1 2 3 4 5 6 7 8 9 A B C D E F G

1

Configuration

Save 1 2 3 4 Mute buzzer

Load 5 6 7 8 Unmute buzzer

2

Select output port

Current routing state

Select input port

1-Matrix control panel

2-System settings

Tips: Input 10~16 are denoted by A~G in this controller.

System Settings:

1) Save: Click 'Save' button then any one of 1-8 button to save current routing status to user preset memory 1~8.

Return: Click 'Load' button then any one of 1-8 button to load routing status from user preset memory 1-8 and apply to current routing.

2) Mute buzzer: Click to turn off the buzzer, the buzzer on the Matrix will not beep when you press any button.

Unmute buzzer: Click to turn on the buzzer, the buzzer on the Matrix will beep when you press any button.

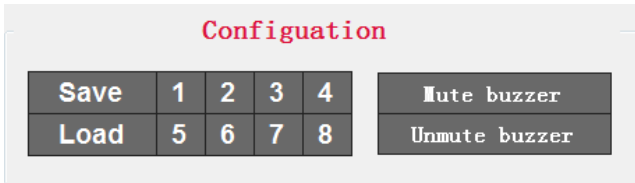

TESmert TESmart

To Enjoy Smart

HMA1616A20

Tesla Elec Technology Co.,Ltd

CE FC   HDCP HDMI

WEEK-Reg.-Nr. DE 66784279