

**TESmert TESmart**

**User** **4x2** Dual Monitor  
DP KVM Switch  
**Manual**   

PKS0802A10

To Enjoy Smart

PKS0802A10

English



**TESmert TESmart**



**English**





## **Preface**

It's our great honor that you have chosen the KVM Switch produced by our company, Tesla Elec Technology Co.,Ltd. In this user manual, you will learn how to operate and use this product. Please read this user manual comprehensively before use. If you have any questions, comments or suggestions, please contact us via the following email:

support@tesmart.com.

## **Copyright Notice**

The user manual, compiled by Tesla Elec Technology Co.,Ltd, shall not be duplicated or translated by any person or organizations without written permission. This user manual shall not be used for commodity transaction in any form or by any means (electronically, mechanically, photocopying or recording, etc.) or be used for any business practices or profitable activities. The ownership of the trade names and brand names adopted in this user manual belongs to their companies.

## **Address of Manufacture**

Tesla Elec Technology Co.,Ltd 2F,  
Building C, Xingzhisheng Industrial Park, No.12,  
Xiawei Industrial Zone, Zhangkengjing Road,  
Guanlan Street,  
Longhua District, Shenzhen City,  
Guangdong Province, China

# Contents

1. Safety Tips and Warnings .....	01	9.4 Auto Scan Mode Description	
2. Battery Description.....	02	9.5 Mouse Wheel Switching	
3. Warranty Information.....	03	10. Operation Method.....	25
4. Preface.....	04	10.1 Front Panel Button Switching Method	
5. Features.....	05	10.2 IR Remote Control	
6. Packing List.....	06	10.3 RS232 Control	
7. Panel Description.....	07	10.4 Keyboard Hot Keys	
8. Connection Description.....	11	11. Change Hot Key Combination.....	32
8.1 Connection Diagram		12. Pass Through Mode Description.....	33
8.2 Connection Preparation		12.1 Introduction of Pass Through Mode	
8.3 Connection Steps		12.2 Keyboard and Mouse Compatible Model List	
8.4 KVM Workbench			
9. Function Description.....	18		
9.1 Display Mode Description			
9.2 EDID Emulator			
9.3 DCCI Description			

## 1. Safety Tips and Warnings

**Tips:** Please read the safety tips and warnings for KVM Switch comprehensively before use. Use this produce in accordance with its instructions, safety tips and warnings to prevent unnecessary damage to the product and potential dangers to users.

- ⚠ Keep the product away from water.
- ⚠ Clean the product with dry cloth.
- ⚠ Use the product in accordance with its instructions and do not block its vents.
- ⚠ Keep the product away from ignition sources, such as heat sinks, heat accumulators, stovepipes and other heat production settings (including audio amplifiers).
- ⚠ Do not touch the product and the power cord with wet hands so as to lower the risk of electric shock and damage to the product. Do not let the product get wet or become damp.
- ⚠ Unplug the power supply of this product in thunderstorm days or when it has been not used for a long time.
- ⚠ Do not expose this product and its battery to open fire or overheating environment. Dispose the waste battery in accordance with instructions.
- ⚠ Users shall not remove and repair the product without authorization.

## 2. Battery Description

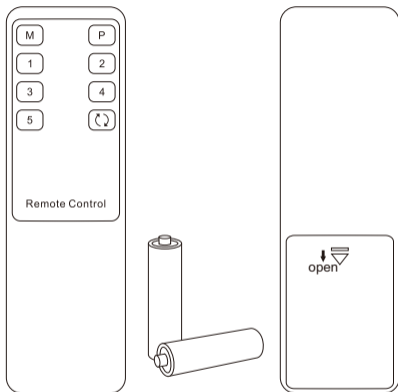

**Tips:** By default, the remote control is not equipped with batteries, due to the safety requirements of some express companies. Install AAA dry cells before use.

**Caution:** Improper disposal of the lithium battery may cause an explosion. Do not throw the battery into fire. Keep the battery away from children. Dispose the waste battery in accordance with local regulations.



### 3. Warranty Information

We warrant this product as free of defects in material and workmanship for a period of one (1) year from the date of shipment. If during the period of warranty this product proves defective under normal use, we will repair or replace this product, provided that this product has not been subjected to mechanical, electrical, or other abuse or modifications. If it fails under conditions other than those covered will be repaired at the current price of parts and labor in effect at the time of repair. Such repairs are warranted for six (6) months from the day of reshipment to the buyer.

## 4. Preface

Dear Users,

4x2 DisplayPort KVM Switch can easily integrate cross-platform computer devices and greatly simplify the devices management. Support managing a dual-display multimedia workstation. If you connect 2 video ports of the same PC to 1 group of input ports on the KVM, you will realize 2-screen extended display or copy display. It has the same effect as connecting the PC directly to 2 displays. The KVM also supports displaying different PCs on 2 monitors.

This KVM supports using USB 2.0 devices and USB keyboard and mouse. Support DCCI, you can extend the connected PCs to up to 4 monitors using 2 of this KVM Switch. At the same time, with EDID emulators in each input port, it can keep PCs always having correct display information.

**Tips:** If you need to control more computers or conduct more complex and professional switching, you can also choose other products of our company. For more details, please visit our official website: [www.tesmart.com](http://www.tesmart.com).

## 5. Features

- Using only 1 set of keyboard, mouse and 2 monitors to control 4 PCs
- Support 2 display modes
- Support Unix/Windows/Debian/Ubuntu/Fedora/Mac OS X/ Raspbian/Ubuntu for Raspberry Pi and other Linux basic system
- Support resolution up to 3840\*2160@60Hz
- Support front panel button, keyboard hotkeys, mouse, wheel, IR remote control and RS232 to control KVM
- Available to use keyboard and mouse without any delay after switching input sources
- With extra USB 2.0 port, it is possible to connect bar code scanner, USB hard device or other USB device
- Support keyboard and mouse pass through mode to improve KVM compatibility
- Support auto scan to monitor computers in a specified time interval
- Support DCCI
- With EDID emulators in each input port, keep PCs always having correct display information

## 6. Packing List

- 1 \* 4x2 DisplayPort KVM Switch
- 8 \* DisplayPort Cables
- 4 \* USB Type-A to Type-B Cables
- 1 \* IR Extension Cable
- 1 \* AUX Cable
- 1 \* IR Remote Control
- 1 \* 3 Pins Connector (For RS232)
- 1 \* DC 12V Power Adapter
- 1 \* User Manual
- 2 \* Rack-ears

**Tips:** After receipt of the product, please check the packing list carefully to make sure that no components have been lost and no damage to the product has been caused during transportation. If you have any problem, please contact us at any time.

## 7. Panel Description

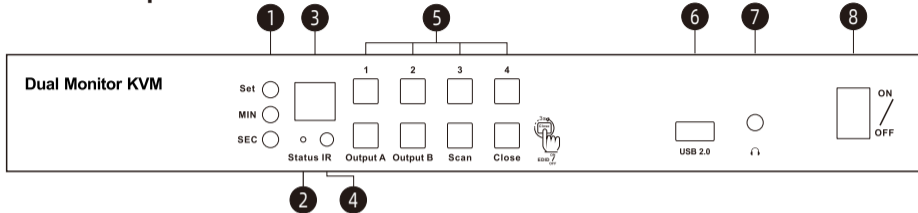

ID	Name	Description
1	Auto scan time interval settings buttons	[SEC]: Set the interval number of seconds; [MIN]: Set the interval number of minutes; [Set]: After setting minutes and seconds, press this button to set final auto scan time interval.
2	Auto scan status indicator	The LED will be red if auto scan mode is turned off; The LED will be blue if auto scan mode is turned on.
3	Digital display	Display current input number and EDID emulator status (use the latter dot).

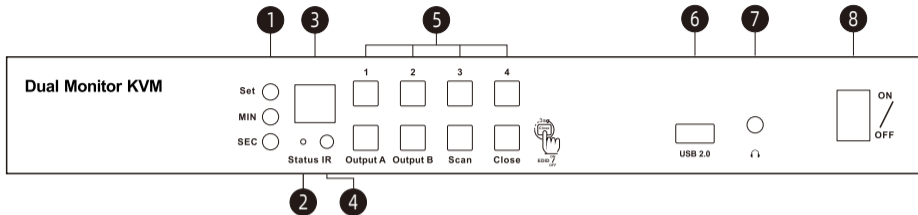

ID	Name	Description
4	IR receiver	Receive IR signal.
5	Keypad	Press to control the Switch. Please refer to Chapter 10.1 for the detail.
6	USB 2.0 port	Connect to USB 2.0 device.
7	L/R out	Connect to audio or L/R output device.
8	Power switch	Turn on or off power supply of the KVM.

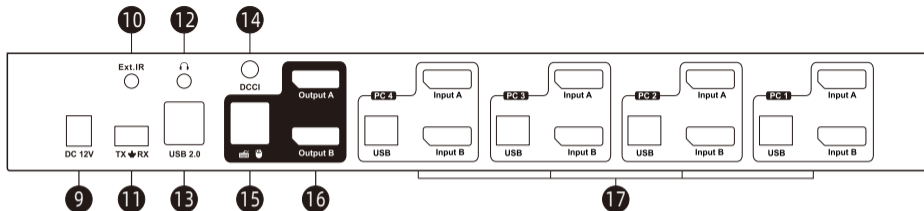

ID	Name	Function
9	DC 12V	12V DC power supply.
10	IR extension in	Connect IR extension cable to this port to receive IR signal even the KVM is installed in a rack.
11	RS232 port	Connect RS232 cable to use RS232 commands to control the KVM.
12	L/R out	Connect to audio or L/R output device.
13	USB 2.0 ports	Connect to USB 2.0 devices.

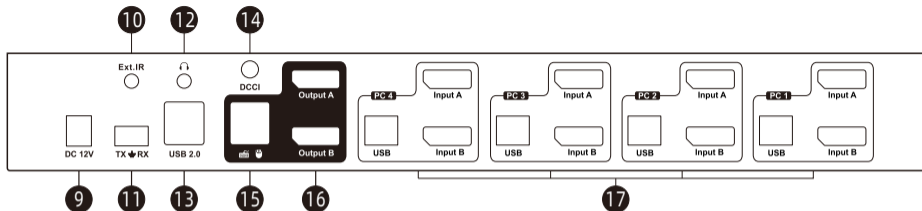

ID	Name	Function
14	DCCI port	Used for product cascading to realize simultaneous display of 4 monitors.
15	Keyboard and mouse input	For USB keyboard and mouse input.
16	DisplayPort outputs	Connect to 2 DisplayPort displays for video output.
17	KVM input ports group	4 PCs can be connected to the KVM at the same time. Each group contains 2 DisplayPort ports(marked as Input A/B) and a USB port. Connect the ports to corresponding input devices for signal input.



## 8. Connection Description

### 8.1 Connection Diagram

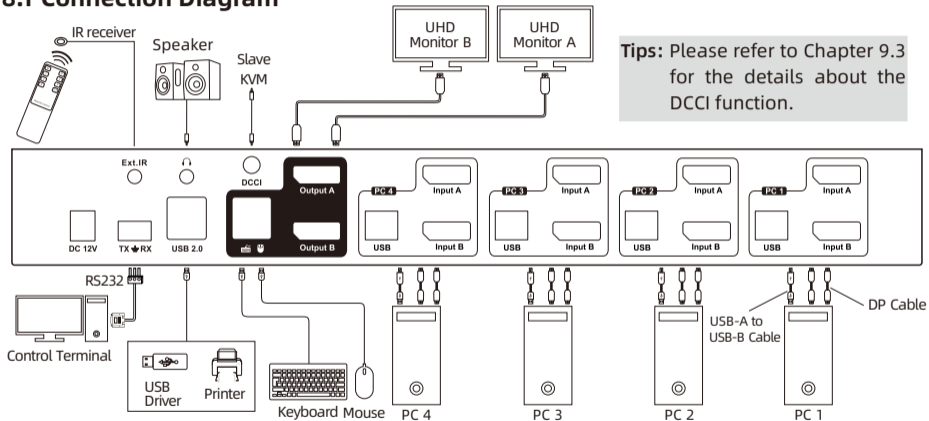

**Tips:** Please refer to Chapter 9.3 for the details about the DCCI function.

**Tips:** For your better use of this product, we suggest you connect each group port on the KVM to the same PC.

## 8.2 Connection Preparation

- Take into consideration all devices required to be connected and prepare a workbench large enough before the connection.
- Lay out the cables properly to facilitate the layout of power supply as a lot of power sockets and plug boards will be adopted in connection.
- Prepare different sticker labels to mark cables as a lot of cables will be adopted in connection.

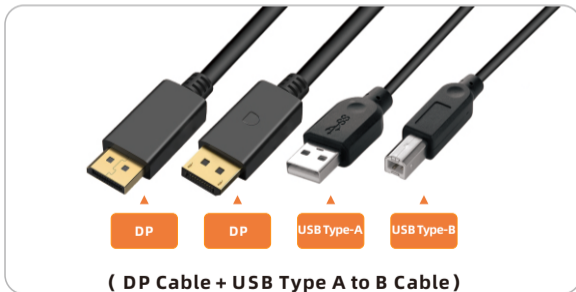

### 8.3 Connection Steps

1. Connect PC1 with 2 DP cables, use DP end to connect PC1 to the corresponding DP ports group on the KVM, use USB-A end to connect each PC and USB-B end to connect the KVM.



2. Connect PC2~4 in the same way as shown above.

3. Connect external mouse and keyboard to KVM's keyboard and mouse input port.

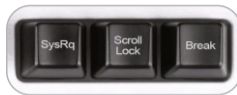

**Tips:** For the normal service of hotkeys, we recommend you use the full-key external keyboard with a separate [Scroll Lock] key (as shown above).

4. Connect USB 2.0 devices to KVM's standard USB 2.0 ports.



5. Connect KVM's DP output ports to 2 DisplayPort displays with 2 DP cables.



7. Connect external audio devices to KVM's L/R out ports.

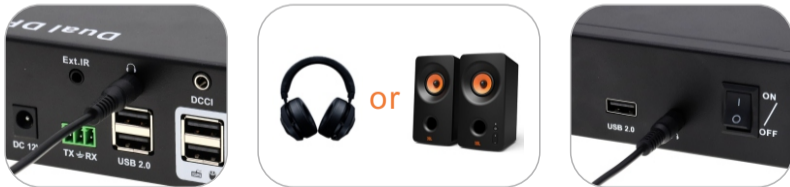

8. Connect the power cable to KVM's DC 12V port and plug it to a power socket.



9. By now, the connection has been completed. Turn on the power supply and the KVM Switch will begin to work.

## 8.4 KVM Workbench

A workbench with 4x2 DisplayPort KVM Switch successfully connected is shown as below:

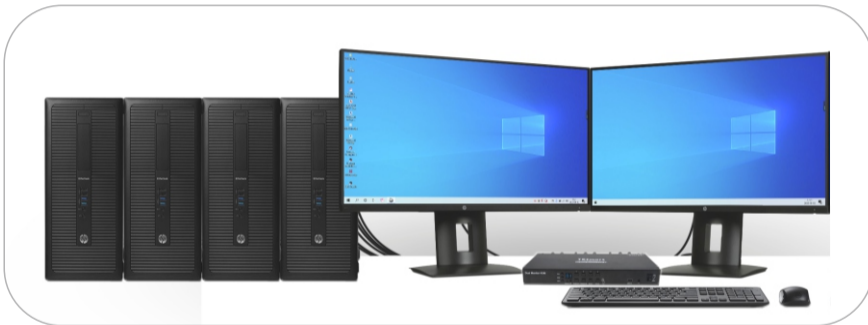

## 9. Function Description

### 9.1 Display Mode Description

The 4x2 DisplayPort KVM Switch support 2 display mode. You can choose to implement 2-screen extended display or duplicate display or display different PCs on 2 monitors.

#### Display Mode 1: The dual monitor mode

Duplicate displays

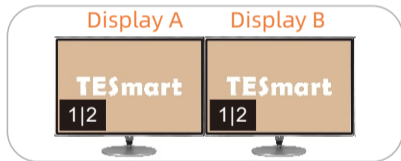

Extend displays

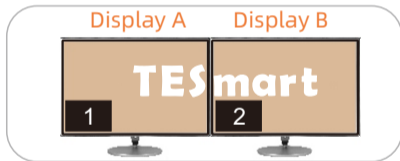

**Tips:** You can set the duplicate or extend displays in the Display Settings of the current selected PC.



## Display Mode 2: The mixed mode

Two monitors respectively show the desktop of two PCs.

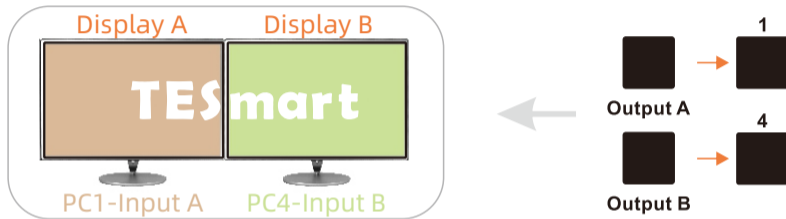

**Tips:** The main screen and the extend screen cannot be interchanged through the KVM on any display mode. That is to say, the image of any 'Input A' cannot be displayed on 'Output B', vice versa. If you want to change the setting, please set in the PC Display Settings manually.

When different PCs are displayed on different monitors, you can double-click the **Right-[Alt]** on the keyboard connected to the KVM to switch the peripheral device focus between different PCs.

## 9.2 EDID Emulator

Our 4x2 DisplayPort KVM Switch with EDID emulators in each input port, keeping PCs always having correct display information. And the KVM will maintain EDID before and after switching, ensure that the window you open stays in the fixed place. Press the key 'Close' on the front panel can enable or disable EDID emulators. The EDID emulators are enabled by default.

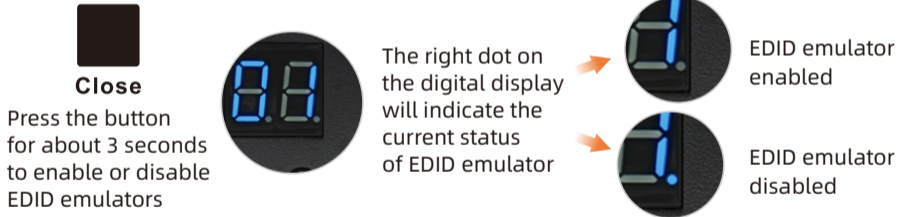

- Tips:**
1. For your better experience, please keep the EDID emulator enabled.
  2. If you encounter some display issues when using the KVM, please disable the EDID emulator and try again.

### 9.3 DCCI Description

With one AUX cable, you can achieve a Quad-monitor KVM switch after cascading two 4x2 DisplayPort KVMs. Cascading can achieve the function of expanding from dual monitors to quad monitors, making your application scenarios broader.

The advantages of DCCI:

- Achieve four extended screens
- Switching is available on both host and slave
- The slave only needs to connect to monitors and computers

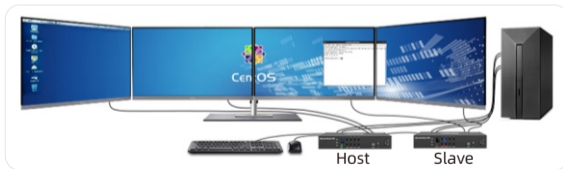

- Tips:**
1. Each computer needs to connect 4 DP cables simultaneously.
  2. The slave does not support connecting keyboard and mouse for use.

The cascade diagram is as shown below:

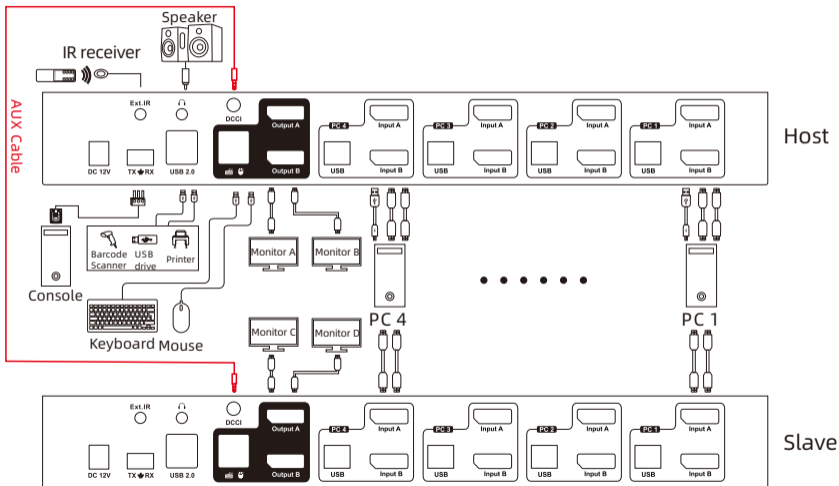

## 9.4 Auto Scan Mode Description

The Auto Scan feature can automatically switch the display at regular intervals between all the input ports. As a result, any input devices connected to each port can be monitored without user intervention. Auto scan mode is off by default. You can turn on the auto scan mode through the front panel keypad, keyboard hot key, infrared remote control, etc.

The LED named 'Status' on the front panel will be lit in different colors when the auto scan mode is turned on or turned off.

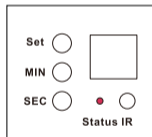

Auto scan mode  
turn off

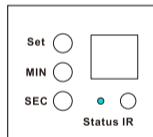

Auto scan mode  
turn on

- Tips:**
1. When auto scan mode is turned on, switching sequence is in the order of PC 1-4, and all displays will display the same PC every time it switches.
  2. Please refer to Chapter 10 for detailed information about how to turn on/off the auto scan mode.

## 9.5 Mouse Wheel Switching

Mouse wheel switching method can quickly switch input sources by mouse operation, double-click the mouse wheel to switch to the next input port. Mouse wheel switching mode is off by default. You can use keyboard hotkey command [Scroll Lock] + [Scroll Lock] + [F6] to turn on mouse wheel switching mode.

## 10. Operation Method

### 10.1 Front Panel Button Switching Method



Set ●

#### Auto scan time interval settings buttons:

Use these buttons to set the time interval from 5 seconds to 1 hour.

MIN ●

Step 1: Press button **[MIN]** to loop between 0~59 minutes.

SEC ●

Step 2: Press button **[SEC]** to loop between 0~59 seconds. When the interval is less than 5 sec, it will be fixed in 5 sec.

Step 3: After setting minutes and seconds, press the button **[Set]** to set final auto scan time interval.



#### 1~4 buttons:

Press directly to switch among 4 PCs. After switching, 2 monitors will display the selected PC at the same time, i.e. the display mode 1.



Output A



Output B

**Display selection button:**

1. Press the button to select the desired monitor, then press the **[1~4]** button to select the desired PC to make the selected monitor display the selected PC. i.e. the display mode 2.
2. Directly press the button to switch the peripheral device focus to the PC which is displayed on the corresponding monitor currently on display mode 2.

**Tips:** For example, if you press the combo like 'A-4' and 'B-2', the image of channel 'Input A' of PC 4 will be displayed on the Display A and the image of channel 'Input B' of PC 2 will be displayed on the Display B right away. Other combos can be deduced by analogy. The operation on the IR remote control are the same.



Scan

**Auto scan mode switch button:**

Press **[Scan]** button to turn on or turn off the auto scan mode.



Close

**Low-power consumption mode button:**

1. Long press **[Close]** button for about 3 seconds to disable or enable EDID emulator.
2. Directly press **[Close]** button to turn off the DP displays to reduce the power consumption. Press it again to turn on the DP displays.



## 10.2 IR Remote Control

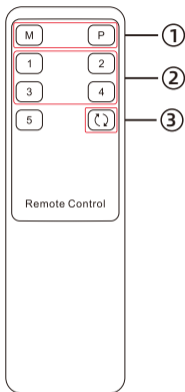

- ① — 1. Press the key [M] or [P] to select the desired monitor, then press the [1~4] button to select the desired PC to make the selected monitor display the selected PC(i.e. the display mode 2)  
2. Directly press the key to switch the peripheral device focus to the PC which is displayed on the corresponding monitor currently on display mode 2.
- ② — Directly press the [1~4] key to make the 2 monitors display the selected PC. (i.e. the display mode 1)
- ③ — Directly press to turn on or turn off auto scan mode.

**Tips:** 1. The key [M] stands for output A, The key [P] stands for output B.  
2. The operation when using the IR remote control is the same as using the front panel buttons. If you want to use the IR remote control to switch between different display modes, please refer to the tips on Page 26.  
3. Unspecified buttons at above are non-functional.

## 10.3 RS232 Control

### A. Connect RS232 port

Follow the below diagram to connect the standard 9 pin RS232 port to the 3 pins connector which is included in package, then plug the connector to the 'TX  $\leftrightarrow$  RX' port of the DP KVM.

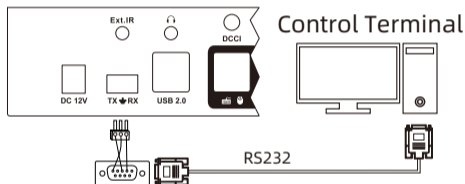
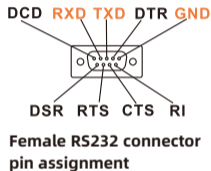

### B. Communication protocol

RS232 port configuration:

Baud rate: 9600 bps

Stop bit: 1 bit

Data length: 8 bits

Parity bit: None

The commands are as the following form(Hexadecimal):

Index	Command strings	Parameter description	Remark
1	AA BB 03 01 XX EE	XX: input port number (01~04)	All outputs are switched to selected inputs
2	AA BB 03 XX YY EE	XX: output port A(03) / output port B(04) YY: next input port(00) / previous input port(01)	Make the monitors display to switch input port respectively
3	AA BB 03 08 XX EE	XX: 00: turn off auto scan 01: turn on auto scan	Auto scan mode status
4	AA BB 03 09 XX YY EE	XX: minutes; YY: seconds (00-3B)	Set the auto scan time interval
5	AA BB 03 05 01		Switch focus on display mode 2
6	AA BB 03 02 XX EE	XX: 00: turn off buzzer XX: 01: turn on buzzer	Set buzzer status

### C. 4x2 DisplayPort KVM Switch Controller

Based on the communication protocol in Section B, you can develop dedicated controllers for each platform.

## 10.4 Keyboard Hot Keys

- Use external keyboard hot keys to switch the input source or set up some other functions.

**Tips:** The keyboard hot keys can only work with external keyboard correctly connected to the keyboard and mouse input port of the KVM. For the use of hot keys, we recommend you use an external keyboard with a separate **[Scroll Lock]** key.

After press **[Scroll Lock]** key twice within 2 seconds and you will hear the buzzer beep once, please enter the commands within 3 seconds and the KVM will execute the corresponding commands.

Select previous input port:

**[Scroll Lock]**→**[Scroll Lock]**→**[PgUp]**



Select port by port number(i.e. the display mode 1):

**[Scroll Lock]**→**[Scroll Lock]**→**[1]~[4]**



Select next input port:

**[Scroll Lock]**→**[Scroll Lock]**→**[PgDn]**



Switch focus on display mode 2:

**[Right-Alt]**→**[Right-Alt]**



Turn on/off mouse wheel switching mode:  
[Scroll Lock] → [Scroll Lock] → [F6]

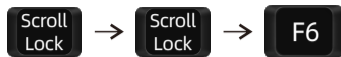

Turn on auto scan mode:  
[Scroll Lock] → [Scroll Lock] → [Space]



**Tips:** The default auto scan time interval is 5 seconds. You can change the time interval by setting on the front panel or following the step presented below.

Increase or decrease auto scan time interval:  
[Scroll Lock] → [Scroll Lock] → [ + ] / [ - ]



**Tips:** This hot key command can only work while the auto scan mode is activated. Press [Scroll Lock] twice and keep pressing [ + ] / [ - ] key to adjust the time interval continuously. Increase or decrease 1 second at one time.

Press [Esc] to exit auto scan mode.



Disable or enable buzzer sound:  
[Scroll Lock] → [Scroll Lock] → [F11]

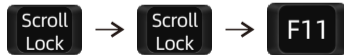

**Tips:** The default setting of buzzer sound is enabled. Repeat this step to disable or enable buzzer sound.

## 11. Change Hot Key Combinations

There are two kinds of trigger hot keys in this product, the default is **[Scroll Lock]** key, and the alternative is the **[Right-Ctrl]** key. If **[Scroll Lock]** Key has been used for other functions, you can switch the hot key to **[Right-Ctrl]** by:

### Method 1:

- 10 seconds after powering on the KVM, press and keep holding the **[Set]** button on the front panel until you hear the buzzer is beeping, then restart KVM.

### Method 2:

- Press **[Scroll Lock]**→**[Scroll Lock]**→**[F1]**, and you will switch the control hot key to **[Right-Ctrl]**.

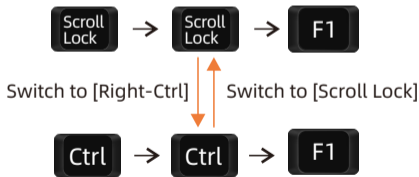

- Vice versa, Press **[Right-Ctrl]**→**[Right-Ctrl]**→**[F1]**, and you will switch the control hot key to **[Scroll Lock]**.

## 12. ~~Pass Through Mode~~ Description

### 12.1 Introduction of Pass through mode

Pass through mode is a built-in function of KVM, which is able to improve keyboard and mouse compatibility and enhance user experience. In the pass through mode, the keyboard and mouse are equivalent to directly connecting to the computer. At this time, you can use more keyboard and mouse functions and special functions that are not supported by traditional KVM.

**Tips:** The current version does not support keyboard and mouse connection via Bluetooth.

## 12.2 Keyboard and Mouse Compatible Model List

**Tips:** The following list is from the most representative models of keyboard and mouse that have been tested in the laboratory, mainly from manufacturers with a high market share.

<b>Brand</b>	<b>Model</b>	<b>Brand</b>	<b>Model</b>	<b>Brand</b>	<b>Model</b>	<b>Brand</b>	<b>Model</b>
<b>Aigo</b>	WQ-641	<b>Logitech</b>	G510	<b>Logitech</b>	Marble Mouse	<b>RAPOO</b>	X220
<b>Dell</b>	KB212-B	<b>Logitech</b>	G710	<b>Logitech</b>	Mk540	<b>RAZER</b>	RZ01-0145
<b>Dell</b>	KB522	<b>Logitech</b>	G910	<b>Logitech</b>	Mx1100	<b>RAZER</b>	RC30-021203
<b>Logitech</b>	G105	<b>Logitech</b>	K400PLUS	<b>Logitech</b>	Mx518	<b>Corsair</b>	K55
<b>Logitech</b>	G500S	<b>Logitech</b>	K845	<b>Microsoft</b>	Wireless Desktop 2000	<b>Corsair</b>	K70LUX





**TESmert TESmart**

**To Enjoy Smart**

PKS0802A10

Tesla Elec Technology Co.,Ltd

CE FC   HDCP 

WEEE-Reg.-Nr. DE 66784279