

TESmart

User **4x2 Hybrid KVM Switch** Manual

HDC402 Prime 23

To Enjoy Smart

HDC402 Prime 23

English



English



Preface

It's our great honor that you have chosen the KVM Switch produced by our company, Tesla Ele Technology Co.,Ltd. In this user manual, you will learn how to operate and use this product. Please read this user manual comprehensively before use. If you have any questions, comments or suggestions, please contact us via the following email:

support@tesmart.com.

Copyright Notice

The user manual, compiled by Tesla Elec Technology Co.,Ltd, shall not be duplicated or translated by any person or organizations without written permission. This user manual shall not be used for commodity transaction in any form or by any means (electronically, mechanically, photocopying or recording, etc.) or be used for any business practices or profitable activities. The ownership of the trade names and brand names adopted in this user manual belongs to their companies.

Product Information

For more information about TESmart products and how they can help you to enjoy your job, please visit the following TESmart website or contact an TESmart Authorized Reseller.

www.tesmart.com

Contents

1. Safety Tips and Warnings	01	9.4 Interchange Display	
2. Battery Description.....	02	9.5 Keyboard and Mouse Emulation Mode	
3. Warranty Information.....	03	9.6 Built-in Charging Module	
4. Preface.....	04	9.7 Built-in Network Switch	
5. Features.....	05	9.8 Lock L/R Audio and USB Focus Function	
6. Packing List.....	06	9.9 Auto Scan Mode Description	
7. Panel Description.....	07	9.10 Mouse Wheel Switching	
8. Connection Description.....	10	10. Operation Method.....	35
8.1 Connection Diagram		10.1 Front Panel Button Switching Method	
8.2 Connection Preparation		10.2 IR Remote Control	
8.3 Connection Steps		10.3 Keyboard Hot Keys	
8.4 KVM Workbench		11. Change Hot Key Combination.....	48
9. Function Description.....	18		
9.1 MST Mode Description			
9.2 Display Mode Description			
9.3 HPD Retention Mode			

1. Safety Tips and Warnings

Tips: Please read the safety tips and warnings for KVM Switch comprehensively before use. Use this produce in accordance with its instructions, safety tips and warnings to prevent unnecessary damage to the product and potential dangers to users.

- ⚠ Keep the product away from water.
- ⚠ Clean the product with dry cloth.
- ⚠ Use the product in accordance with its instructions and do not block its vents.
- ⚠ Keep the product away from ignition sources, such as heat sinks, heat accumulators, stovepipes and other heat production settings (including audio amplifiers).
- ⚠ Do not touch the product and the power cord with wet hands so as to lower the risk of electric shock and damage to the product. Do not let the product get wet or become damp.
- ⚠ Unplug the power supply of this product in thunderstorm days or when it has been not used for a long time.
- ⚠ Do not expose this product and its battery to open fire or overheating environment. Dispose the waste battery in accordance with instructions.
- ⚠ Users shall not remove and repair the product without authorization.

2. Battery Description

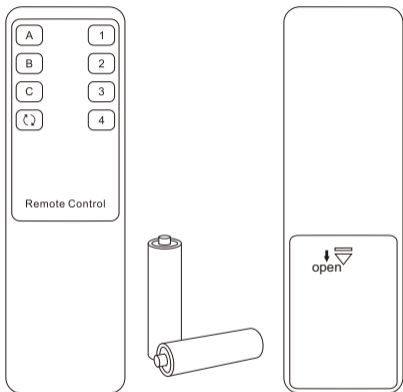

Tips: By default, the remote control is not equipped with batteries, due to the safety requirements of some express companies. Install AAA dry cells before use.

Caution: Improper disposal of the lithium battery may cause an explosion. Do not throw the battery into fire. Keep the battery away from children. Dispose the waste battery in accordance with local regulations.

3. Warranty Information

We warrant this product as free of defects in material and workmanship for a period of one (1) year from the date of shipment. If during the period of warranty this product proves defective under normal use, we will repair or replace this product, provided that this product has not been subjected to mechanical, electrical, or other abuse or modifications. If it fails under conditions other than those covered will be repaired at the current price of parts and labor in effect at the time of repair. Such repairs are warranted for six (6) months from the day of reshipment to the buyer.

4. Preface

Dear Users,

4x2 Hybrid KVM Switch can easily integrate cross-platform computer devices and greatly simplify the devices management. Support managing a dual-display multimedia workstation. Support MST mode, connect a USB-C cable from PC to the KVM Switch have the same effect as connecting the PC directly to 2 displays. The KVM also support displaying different PCs on 2 monitors.

This KVM support USB 3.2 Gen 1 with superspeed data transfer rate. With a high-power supply that allows you to charge your laptops that are connected to the KVM directly and securely. With USB charge port on the front panel, support BC 1.2 protocol to charge devices like mobile phones and tablets. Support wired network connection, 4 PCs connected to KVM can access to the network with only one network cable. At the same time, with EDID emulators in each input port, it can keep PCs always having correct display information.

Tips: If you need to control more computers or conduct more complex and professional switching, you can also choose other products of our company. For more details, please visit our official website: www.tesmart.com.

5. Features

- Using 2 monitors, 1 set of keyboard and mouse to control 4 computers
- Support resolution up to 3840x2160@60Hz 4:4:4
- Support MST(Multi-Stream Transport) mode
- Support DisplayPort Alternate Mode (DP Alt Mode)
- Support 2 display modes
- Support Unix/Windows/ Debian/ Ubuntu/Fedora/ MacOS X/ Raspbian/ Ubuntu for Raspberry Pi and other Linux based systems
- Support wired network connection, 4 PCs connected to KVM can access to the network with only one network cable
- Support locking L/R audio and USB 3.0 devices to a fixed PC
- With EDID emulators in each input port, it can keep PCs always having correct display information
- Support USB 3.2 Gen 1 with super-speed data transfer rate
- Keyboard and mouse support passthrough mode and legacy emulation mode, significantly improving compatibility for keyboards and mice
- Support charging the devices connected to the ports marked 'PC1' and 'PC2'
- Support connecting mobile device to the front panel USB ports to charge

6. Packing List

- 1 * 4x2 Hybrid KVM Switch
- 2 * KVM Cables
- 2 * DP Cables
- 4 * USB-C Cables
- 1 * IR Remote Control
- 1 * DC 20V Power Adapter
- 1 * User Manual
- 2 * Rack-ears

Tips: After receipt of the product, please check the packing list carefully to make sure that no components have been lost and no damage to the product has been caused during transportation. If you have any problem, please contact us at any time.

7. Panel Description

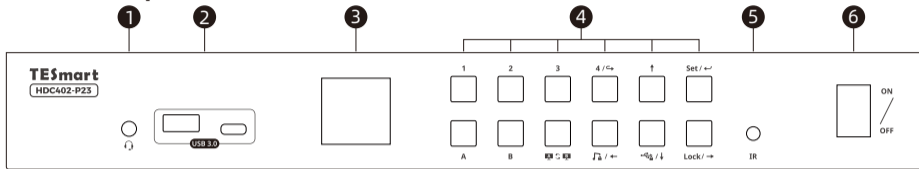

ID	Name	Function	ID	Name	Function
1	3.5mm audio&mic	Integrated microphone and L/R audio output.	2	Data transfer and charging port	Can be used to transfer data and charge your mobile devices.
3	Color LCD	Display current status and function settings.	4	Keypad	Press to control the KVM. Please refer to Chapter 10.1 for the detail.
5	IR receiver	Receive IR remote signal.	6	Power switch	Turn on or turn off power supply.

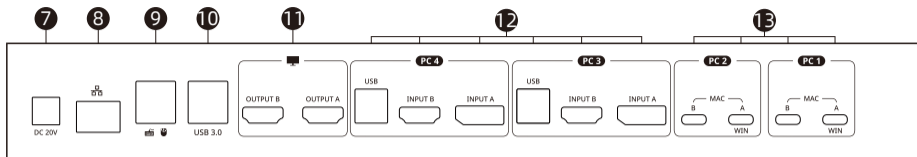

ID	Name	Function
7	DC 20V	20V DC power supply.
8	LAN port	Insert the network cable into this port to let the 4 input PCs to connect to the local network area.
9	Keyboard and mouse input	For USB keyboard and mouse input.
10	USB 3.2 Gen 1 ports	Connect to USB 3.0 devices.
11	HDMI outputs	Connect to 2 HDMI displays for video output.

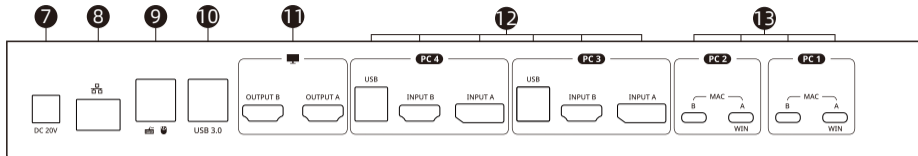

ID	Name	Function
12	General devices connection ports	Each group contains 1 DP port and 1 HDMI port (marked as Input A&B) and a USB port. Connect the ports to corresponding input devices for signal input. Devices connected to these ports CANNOT be charged.
13	Type-C charging devices connection ports	Each group contains 2 type-C ports. Connect the ports to the devices with type-C ports for signal input. Connect the device to the port marked 'A' to charge it. Please refer to Page 12~13 for how to connect laptops with different operating systems.

8. Connection Description

8.1 Connection Diagram

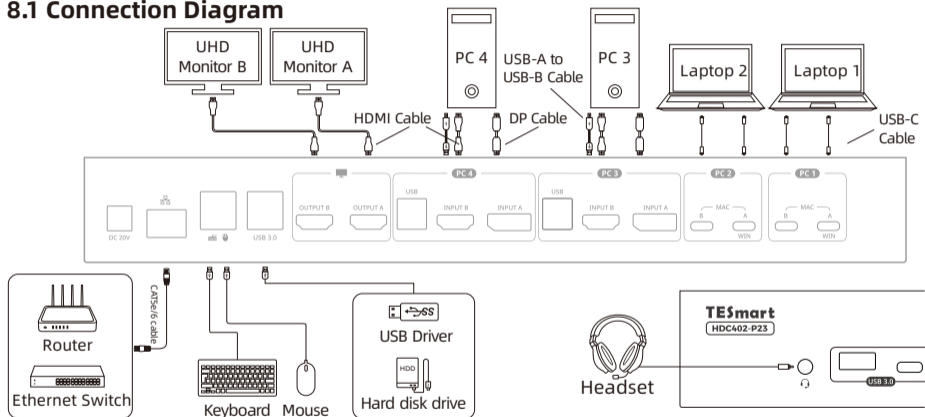

Tips: For your better use of this product, we suggest you connect each group port on the KVM to the same PC.

8.2 Connection Preparation

- Take into consideration all devices required to be connected and prepare a workbench large enough before the connection.
- Lay out the cables properly to facilitate the layout of power supply as a lot of power sockets and plug boards will be adopted in connection.
- Prepare different sticker labels to mark cables as a lot of cables will be adopted in connection.

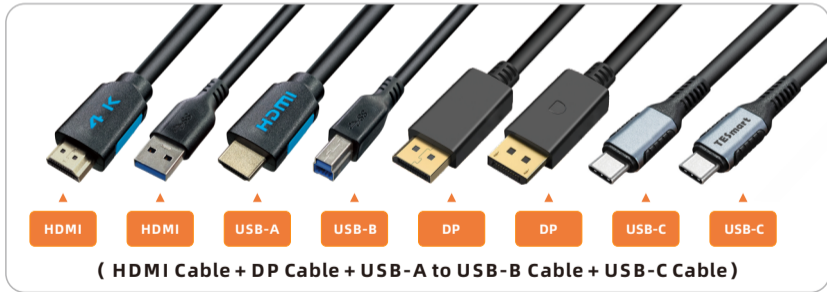

8.3 Connection Steps

1. Connect PC 1 and PC 2 in different cases as follows.

- **A. If your Type-C laptops are running Windows OS:**

Connect 2 laptops to the Input ports marked 'A' of each input group of the KVM with 2 USB-C cable to enable the MST mode. Connect 2 PCs to the Input 'A' & 'B' or only Input ports marked 'B' of each input group to disable the MST mode (As shown below).



Tips: Please refer to Page 18 for the detailed information about the MST mode.



- **B. If your Type-C laptops are running MacOS:**

Connect 2 laptops to the Input 'A' & 'B' ports of each input group of the KVM with 4 USB-C cable.



2. Connect PC 3 with 1 HDMI cable and 1 KVM cable and connect PC 4 the same way.



3. Connect external mouse and keyboard to KVM's keyboard and mouse input port.



4. Connect USB 3.0 devices to the USB 3.2 ports.



5. Connect KVM's HDMI output ports to 2 HDMI displays with 2 HDMI cables.



6. Use the network cable to connect the LAN port on the KVM Switch to a router or local area network switch.



7. Connect external audio device to KVM's audio port.

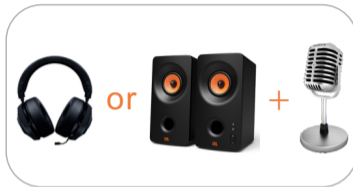

8. Connect the power cable to KVM's DC 20V port and plug it to a power socket.



Tips: 1. Please refer to Page 30 for how to use the front panel charging port.
2. Please refer to Page 31 for the detailed information about the LAN port.

By now, the connection has been completed. Turn on the power supply and the KVM Switch will begin to work.

8.4 KVM Workbench

A workbench with 4x2 Hybrid KVM Switch successfully connected is shown as below:



9. Function Description

9.1 MST Mode Description

The traditional dual monitor KVM switch needs to connect two cables to each input device for the normal use of the dual monitor function. But our 4x2 dual monitor KVM Switch support Multi-Stream Transport(MST) mode allowing dual HDMI displays from a single USB-C source.

- **Multi-Stream Transport mode:**

If your Windows OS PC with USB-C port and is DisplayPort 1.2 compliant, you can adopt two console displays from it. Support extend mode and duplicate mode at resolutions up to 4K for multitasking across two displays.

- **Operation method**

Connect USB-C input devices and 2 UHD monitors according to the pictures in next page, the display mode will enable MST mode automatically.

Tips: Up to now, devices running Apple's MacOS, Ubuntu and other operating systems do not support MST mode.

- **Enable MST mode**

Connect the laptop to the input port marked 'A' on the KVM with a single USB-C cable. The other laptop is the same.

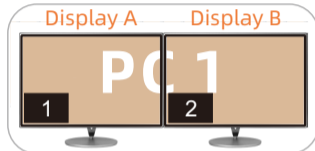

Tips: 1. Only the port marked 'A' supports the MST mode.

2. As shown below, if your PC is not Windows OS and has 2 USB-C ports supporting video output, connecting them to the input port group will also enable dual monitor displays.

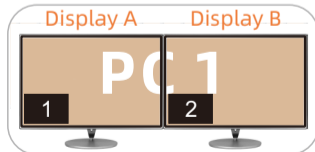

9.2 Display Mode Description

The 4x2 dual monitor KVM Switch support 2 display mode. You can choose to implement 2-screen extended display or duplicate display or display different PCs on 2 monitors.

Display Mode 1: The KVM mode



Tips: You can set the duplicate or extend displays in the Display Settings of the current selected PC.

Display Mode 2: The Matrix mode

You can match any display and any input view at will at this mode. Here are 3 examples.

- 1. Matching mode (A-A,B-B)

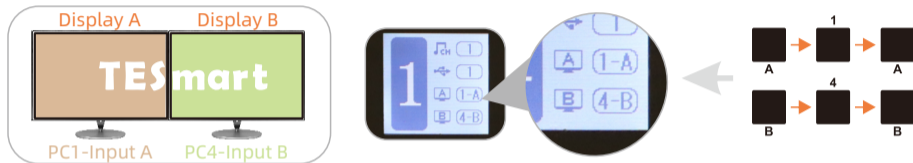

The selected Input A/B are correspondingly displayed on Display A/B.

- 2. Crisscross mode (A-B,B-A)

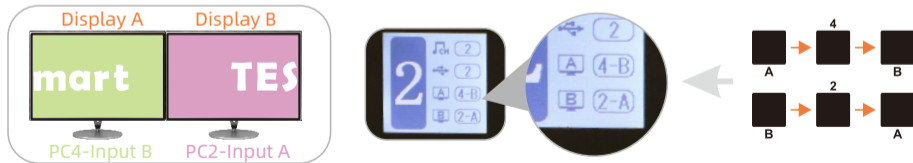

The correspondence of the input and display are intersecting.

- 3. Splitter mode

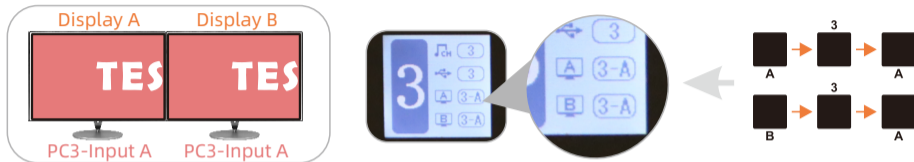

The 2 displays select the same input port.

When different PCs are displayed on different monitors, you can double-click the **Right-[Alt]** on the keyboard connected to the KVM to switch the focus between different PCs.

Tips: When MST is enabled, the input ports represented by PC1 and PC2, '1-A, 1-B, 2-A, 2-B', will be determined by the operating system. If you want to adjust the main and sub screen and their display order, please adjust them in the corresponding PC's display settings.

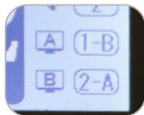

9.3 HPD Signal Retention Mode

The normal working between PCs, displays and the KVM has resulted in a need for standardized communication protocols, one such protocol is the HPD signal. If the signal changes to high-level within a specified time period, it indicates that the display has been plugged in and vice versa.

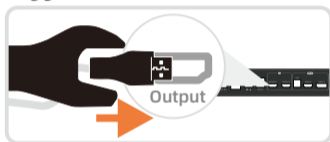

Plug the display to the KVM



Device recognizes the display is plugged in and outputs the image.

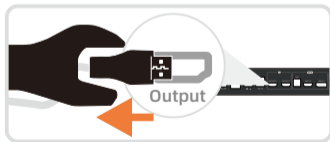

Unplug the display



Device recognizes the display is unplugged and shut it down.

Through the input and output ports of the KVM, we can see that there are 8 sets of input channels and 2 sets of output channels on the KVM. The 2 sets of output channels can display images from up to 2 sets of input channels. The input channels that are being displayed are referred to as active channels, while the channels that are not being displayed are referred to as inactive channels.

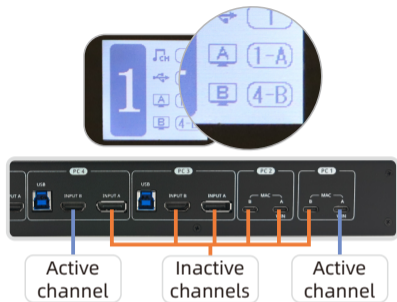

We have set up a switch mode for retaining the HPD signal, which can be enabled or disabled according to your needs. Use keyboard hot key to enable or disable the HPD retention mode. HPD retention mode is enabled by default. You can use keyboard hotkey command [Right-Ctrl] + [Right-Ctrl] + [F5] to switch states.



Buzzer beep once indicates the mode is disabled



Buzzer beep twice indicates the mode is enabled



When HPD signal retention mode is enabled, the KVM switch keeps the HPD signal of inactive input channels in a high-level state. This way, even if the user switches to a new input channel, the HPD signal of the previous channel remains in a high-level state, maintaining a stable display output.



When HPD signal retention mode is disabled, if you switch to an inactive input channel, the KVM switch will recognize the low-level state of the HPD signal and automatically disconnect the corresponding display. When you switch back to that computer, the switch will automatically restore the connection.

Here we have listed some usage scenarios for your reference based on different status of the HPD retention mode.

- A.** If you have the following requirements for your working environment, we recommend **enabling** the HPD retention mode.
- If you are using a laptop screen while connecting your laptop to the KVM Switch and want to avoid black or distorted screens when switching input channels.
 - If you want to prolong the lifespan of the display screen by reducing wear and tear caused by frequent on/off cycles.

- B.** If you have the following requirements for your working environment, we recommend **disabling** the HPD retention mode.
- Upon switching to display mode 2, the mouse cursor and opened windows cannot be found on the displayed screen. (This depends on the internal processing of the computer operating system.)
 - If you want to ensure that your displays are only active when you are actively using them, conserving energy and prolonging the life of your equipment.

9.4 Interchange Display

The 4x2 KVM Switch support interchange the image displayed on the 2 monitors with 1 press.



Tips: The 2 monitors will not interchange the image when:
A. The maximum resolutions supported by them are different.
B. In display mode 2 and the HPD retention mode is enabled.

9.5 Keyboard and Mouse Emulation Mode

We provide two keyboard and mouse modes: Pass Through Mode and Legacy Emulation Mode. Pass Through mode supports most keyboard and mouse drivers and multifunction keyboards and mice. Legacy Emulation Mode ensures the normal functioning of the keyboard, mouse, and hotkey features.

- Typically, we recommend using Passthrough Mode for an optimal user experience, allowing you to:



If you encounter issues with the keyboard and mouse in Passthrough Mode, we recommend switching to Legacy Emulation Mode.

- Tips:**
1. To toggle between two modes, please refer to Page 44. After toggled, please restart the KVM.
 2. In Legacy Emulation Mode, the keyboard and mouse control software will no longer be available.

9.6 Built-in Charging Module

The 4x2 dual monitor KVM Switch comes with a powerful built-in charging module that allows you to charge your laptops, phone, tablet and other devices while you use it.

- Connect the laptops to the rear Type-C video port of the KVM and they will be charged via the PD protocol.



Tips: Laptops connected only to PC 1 and PC 2 can be charged.

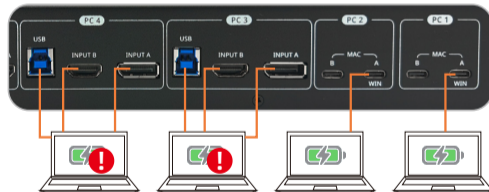

- Tips:**
1. The USB-C port on the laptop needs to support the charging protocol to be able to charge.
 2. Only by connecting the device to the port marked 'A' can it be charged.

Tips: When the laptop is connected to both the KVM and the original charger, the charger will give priority to charge it.

- Connect the tablet, phone, ect to the front USB-A or USB-C port and they will be charged.

Use the USB ports on the front panel of the KVM (including an USB-A and an USB-C ports) can support data transmission while charging. The USB port support BC 1.2 protocol, and are able to match voltage and current automatically based on the specifications of charging devices. It makes your charging safe and avoid damage.



9.7 Built-in Network Switch

The 4x2 KVM Switch have a built-in USB Ethernet Adapter, which adds a standard RJ45 port to all the PC that is connected to the KVM and allows you to connect your computers to a router or network switch for gigabit wired network connection. Full 1000Mbps Ethernet for fast, stable data transfer, more reliable than most wireless connections. This feature has been added with a switch, allowing you to freely choose to enable or disable it.

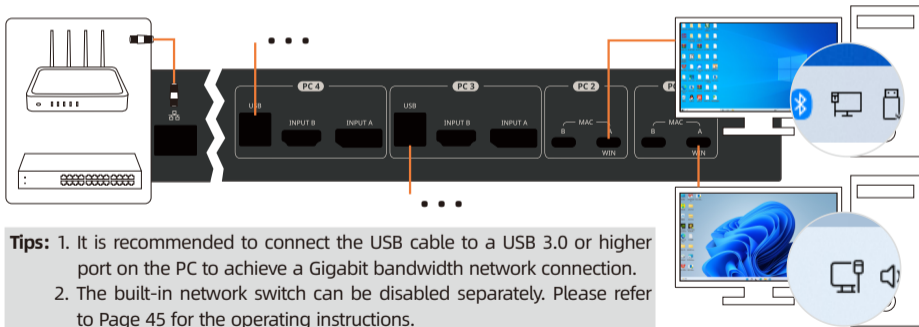

- Tips:**
1. It is recommended to connect the USB cable to a USB 3.0 or higher port on the PC to achieve a Gigabit bandwidth network connection.
 2. The built-in network switch can be disabled separately. Please refer to Page 45 for the operating instructions.

9.8 Lock L/R Audio and USB Focus Function

The 4x2 KVM Switch supports locking L/R audio and USB 3.0 focus. After the lock is turned on, the current audio or USB focus can be maintained and only the screen can be switched when switching; the audio focus lock and USB 3.0 focus lock are independent of each other, you can lock the audio or lock the USB separately. Only need to press the front panel keys to operate audio or USB focus lock.

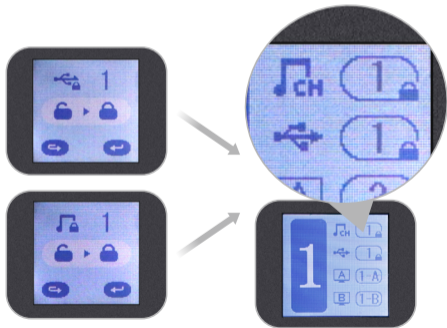

- Tips:**
1. The keyboard & mouse focus and USB focus are independent of each other, and the keyboard and mouse focus cannot be locked. When switching between different input sources in display mode 2, the keyboard and mouse focus will not change with the switch.
 2. The lock state is maintained after the KVM is powered off.
 3. Please refer to Chapter 10.1 for detailed information about how to lock/unlock audio or USB.

9.9 Auto Scan Mode Description

The Auto Scan feature can automatically switch the display at regular intervals between the input devices that are powered on and connected to the KVM. As a result, any input devices connected to each port can be monitored without user intervention. Auto scan mode is off by default. You can turn on the auto scan mode through the front panel keypad and keyboard hot key.

After the auto scan mode is turned on, the lower left corner in the main menu interface of the LCD will appear a white 'SCAN'.



- Tips:**
1. When auto scan mode is turned on, regardless of the current routing status, all monitors will display PC 1 at first. When scanning, switch in the order of PC 1-4, and all displays will display the same PC every time it switches.
 2. Please refer to Chapter 10 for detailed information about how to turn on/off the auto scan mode.

9.10 Mouse Wheel Switching

Mouse wheel switching method can quickly switch input sources by mouse operation, double-click the mouse wheel to switch to the next input port. Mouse wheel switching mode is off by default. You can use keyboard hotkey command to turn on mouse wheel switching mode. Please refer to Page 34.















10. Operation Method

10.1 Front Panel Button Switching Method



When you use the front panel button or IR remote to control the KVM, the LCD display will inquiry your target action, then execute the command according to your operation. The LCD interface in the figure above is the main interface.

Schematic table of LCD interface and panel icons:

Icon	Meaning and Function	Icon	Meaning and Function
	Monitor A/B and channel A/B in each input port group.		Interchange display icon, press to interchange the image displayed on the 2 monitors.
	USB focus icon, indicating the PC where the external USB 3.0 device focus is currently located.		Keyboard and mouse focus icon, indicating the PC where the keyboard and mouse focus is currently located.
	Audio lock icon, indicating that the current audio is locked on the PC corresponding to the number behind the  icon on the main interface.		USB lock icon, indicating that the current USB 3.0 devices are locked on the PC corresponding to the number behind the  icon on the main interface.
	Return button.		Enter button.
	Audio focus icon, indicating the PC where the external audio focus is currently located.		The content behind each icon indicates that the corresponding channel is displayed on the monitor.



1~4 button:

1. Press directly to switch among 4 PCs. After switching, 2 monitors will display the selected PC at the same time, i.e. the KVM mode.
2. In the settings interface, press [4 / ⇄] to return to the main interface.



Display selection button:

Directly press the button to select the desired monitor, according to the prompt of the LCD screen, press the [1~4] button to select the desired PC, then press [A] or [B] to make the selected monitor display the selected PC. i.e. the Matrix mode.





Tips: For example, if you press the combo like 'A-1-B', 'B-2-A', the image of channel 'Input B' of PC 1 will be displayed on the Display A and the image of channel 'Input A' of PC 2 will be displayed on the Display B right away. i.e. the crisscross mode of the Matrix mode. Other modes can be deduced by analogy. The operation on the IR remote control are the same.







Interchange display button:

Directly press the button, the image displayed on the 2 monitors will be interchanged.

**Audio lock button:**

1. Directly press [] button, follow the prompts on the LCD screen, then press the [Set / ] button to lock the L/R audio to the current PC. Any operation after locking will not change the locked state. Press the key again in the locked state, and then press the [Set / ] button to unlock.
2. In the menu and setting interface, press [] button to page forward or select to the left.

**USB lock button:**

1. Directly press [] button, follow the prompts on the LCD screen, then press the [Set / ] button to lock the external USB 3.0 devices to the current PC. Any operation after locking will not change the locked state. Press the key again in the locked state, and then press the [Set / ] button to unlock.
2. In the settings menu, Press [] button to select down.

**Select up button:**

- In the settings menu, Press [] button to select up.



Lock button:

Lock /→

1. Press [**Lock /→**] button to lock the KVM. After locking, all displays will be off, audio output will be paused, and LCD screen brightness will be reduced to a minimum, all buttons will be invalid. Press [**Lock /→**] button again to light up the LCD screen, then enter the PIN to unlock.
2. In the menu and setting interface, press [**Lock /→**] button to page backward or select to the right.

Tips: 1. You can modify your PIN in settings menu.
2. If you forget your PIN, you can restore the factory default settings to unlock. The default PIN is 1234. Press and hold the [**Lock /→**] for about 10 seconds to restore the factory default settings.
3. IR remote control and keyboard hot keys are invalid when KVM is locked.

Set /←



Settings button:

1. Press the button, according to the LCD screen prompts, you can set up **save or load preset scenes, enable or disable auto scan, set auto scan time, enable or disable buzzer, set hotkey trigger key, enable or disable HPD retention, set screen brightness, change PIN, factory reset** in the menu. Use the [**♪ /←**][**Lock /→**] key to select among different options under each setting.

Set / ← 2. In the menu and setting interface, press [Set / ←] button to confirm.



Tips: 1. Only numbers 1,2,3,4 on the front panel of the KVM are available when changing PIN. You can also set the PIN to null to unlock without a password.
2. Under the PIN modification interface, the button [🔒 / ←] is used as the return button.

Tips: The setting status in the interface is automatically synchronized with the current settings, and the selected option is indicated by the dark color.

10.2 IR Remote Control

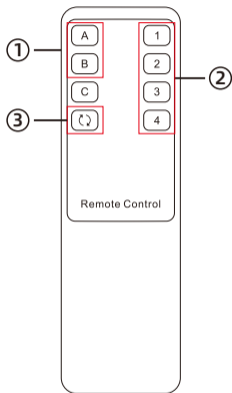

- ① — Press the key **[A]** or **[B]** to select the desired monitor, according to the prompt of the LCD screen, press the **[1~4]** button to select the desired PC, then press **[A]** or **[B]** to make the selected monitor display the selected PC (i.e. the display mode 2)
- ② — Directly press the **[1~4]** key to make the 2 monitors display the selected PC. (i.e. the display mode 1)
- ③ — Directly press to interchange the display.

Tips: 1. The operation when using the IR remote control is the same as using the front panel buttons. If you want to use the IR remote control to switch between different display modes, please refer to the tips on Page 37.

2. Unspecified buttons at above are non-functional.

10.3 Keyboard Hot Keys

→ Use external keyboard hot keys to switch the input source or set up some other functions..

Tips: The keyboard hot keys can only work with external keyboard correctly connected to the keyboard and mouse input port of the KVM.

After press **[Right-Ctrl]** key twice within 2 seconds and you will hear the buzzer beep once, please enter the commands within 3 seconds and the KVM will execute the corresponding commands.

Select previous input port:

[Right-Ctrl]→**[Right-Ctrl]**→**[PgUp]**



Select next input port:

[Right-Ctrl]→**[Right-Ctrl]**→**[PgDn]**



Select port by port number(i.e. the display mode 1):

[Right-Ctrl]→**[Right-Ctrl]**→**[1]~[4]**



Switch PCs on different monitors separately(i.e. the display mode 2):

Monitor A: [Right-Ctrl] → [Right-Ctrl] → [←] → [1]~[8]



Monitor B: [Right-Ctrl] → [Right-Ctrl] → [→] → [1]~[8]



Tips: 1. '←' stands for Display A, '→' stands for Display B.

2. 1~8 stands for all 8 input channels. It means 1 stands for input A of PC 1, 2 stands for input B of PC 1, 3 stands for input A of PC 2,...,8 stands for input B of PC 4, and so on.

For example, if you press the hotkey command 'Right-Ctrl + Right-Ctrl + ← + 7' and 'Right-Ctrl + Right-Ctrl + → + 7', the image of channel 'Input A' of PC 4 will be displayed on both the Display A and Display B right away. i.e. the splitter mode of the Matrix mode.

Switch focus in display mode 2: [Right-Alt]→[Right-Alt]



Switch USB 3.0 devices connected to the KVM between 4 PCs on display mode 2:
[Right-Ctrl] → [Right-Ctrl] → [↑]



Switch audio focus between 4 PCs on display mode 2:
[Right-Ctrl] → [Right-Ctrl] → [↓]



Toggle between keyboard and mouse modes:
[Right-Ctrl] → [Right-Ctrl] → [F2]



Tips: The default keyboard and mouse mode is Pass Through mode. When switching to Legacy Emulation Mode, the buzzer will emit 2 short beeps; when switching to Pass Through Mode, the buzzer will emit only 1 short beep. It is recommended to restart the KVM after switching modes.

Disable/enable fan:

[Right-Ctrl] → [Right-Ctrl] → [F3]



Tips: The fan has 4 adjustable modes, distinguishable by the number of beeps from the buzzer. The default fan mode is 2.

Fan mode 1: The fan is disabled. Adjust to this mode, the buzzer will beep once.

Fan mode 2: The fan operates based on the actual temperature: it automatically turns on when the detected chip temperature exceeds 55°C and turns off when the temperature drops below 45°C. Adjust to this mode, the buzzer will beep twice.

Fan mode 3: The fan operates at low speed continuously. Adjust to this mode, the buzzer will beep three times.

Fan mode 4: The fan operates at high speed continuously. Adjust to this mode, the buzzer will beep four times.

Disable/enable built-in network card:

[Right-Ctrl] → [Right-Ctrl] → [F4]



Tips: The built-in network card is enabled by default. This operation only applies to the current PC. Enable it will trigger the buzzer to beep twice and disable it will trigger the buzzer to beep once.

Turn on/off HPD retention mode:

[Right-Ctrl] → [Right-Ctrl] → [F5]



Tips: The buzzer will beep once to indicate that the HPD retention mode is enabled and twice to indicate that it is disabled. Enable it will trigger the buzzer to beep twice and disable it will trigger the buzzer to beep once.

Turn on/off mouse wheel switching mode:

[Right-Ctrl] → [Right-Ctrl] → [F6]



Tips: Turning on the mouse wheel switching mode will trigger the buzzer to beep twice and turning it off will trigger the buzzer to beep once.

Disable or enable buzzer sound:

[Right-Ctrl] → [Right-Ctrl] → [F11]



Tips: The default setting of buzzer sound is enabled. Disable buzzer sound will trigger the buzzer to beep once and enable it will trigger the buzzer to beep twice.

Turn on auto scan mode:

[Right-Ctrl] → [Right-Ctrl] → [Space]



Tips: The default auto scan time interval is 5 seconds. You can change the time interval by setting on the LCD menu or following the step presented below.

Increase or decrease auto scan time interval:

[Right-Ctrl] → [Right-Ctrl] → [+] / [-]



Tips: This hot key command can only work while the auto scan mode is activated. Press [Right-Ctrl] twice and keep pressing [+] / [-] key to adjust the time interval continuously. Increase or decrease 1 second at one time.

Press [Esc] to exit auto scan mode.



11. Change Hot Key Combinations

There are three kinds of trigger hot keys in this product, the default is **[Right-Ctrl]** key, and the alternative are the **[Scroll Lock]** and **[Left-Ctrl]** key. You can switch the hot key to others by:

Method 1:

- Change the hot key through the settings in the LCD menu, press the **[Set /↶]** key and find the "Hot key" option to set.

Method 2:

- Press keyboard hot keys to cyclically switch the control hot key.

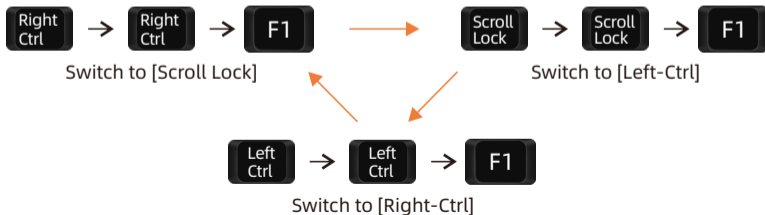

TESmart

To Enjoy Smart

HDC402 Prime 23

Tesla Elec Technology Co.,Ltd

CE FC   HDCP 

WEEE-Reg.-Nr. DE 66784279